

## USB Multi-Function Dataloggers

### RHT30 Humidity/Temperature Datalogger

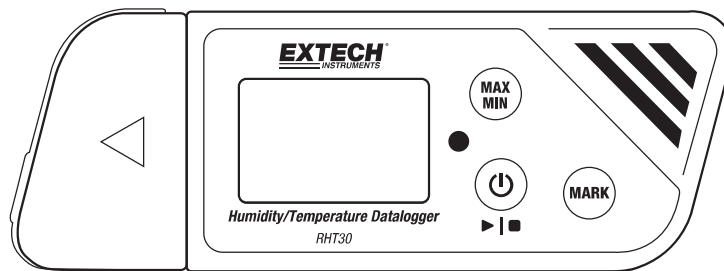

### TH30 Dual Temperature Datalogger

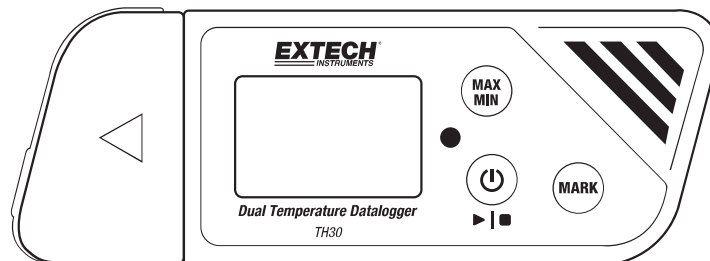

# Introduction

---

Thank you for selecting the Extech multi-function, easy-to-use, portable USB datalogger. The RHT30 offers temperature and humidity logging and the TH30 offers internal (air) and external (probe) temperature logging.

These USB dataloggers can be configured and customized by the user by plugging them into a PC USB port, following the on-screen prompts, and making selections on the supplied 'PDF Logger Configuration Tool'.

These devices are shipped fully tested and calibrated and, with proper use, will provide years of reliable service. Please visit our website ([www.extech.com](http://www.extech.com)) to check for the latest version of this User Manual, Product Updates, and Customer Support.

# Features

---

- Plug-and-play datalogger with USB connector. No USB driver required
- User configurable datalogging settings via supplied PC software tool
- Advanced Datalogger functions including delayed start, high/low alarms, bookmarking, and password protection
- Automatically generate PDF and Microsoft® Excel® datalog reports
- High accuracy thermistor temperature sensor on both models with capacitive humidity sensor on the RHT30
- Compact light-weight design
- Large LCD for easy viewing
- Dual color (red and green) LED status indicator for datalogger progress, PC connection status, and high/low alarms
- Large memory capacity: 48,000 readings

# Descriptions

---

## Datalogger Description

1. External temperature sensor (TH30 only)
2. External temperature sensor connection to datalogger (TH30 only)
3. Protective cover and swivel stand (remove to expose USB plug). Rotate the cover for best desktop viewing angle.
4. LCD display. Refer to the Display Description later in this section.

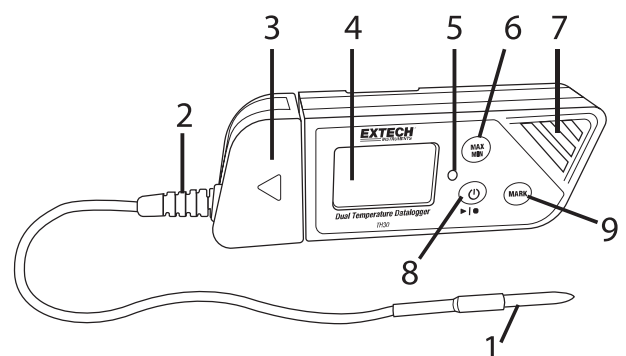

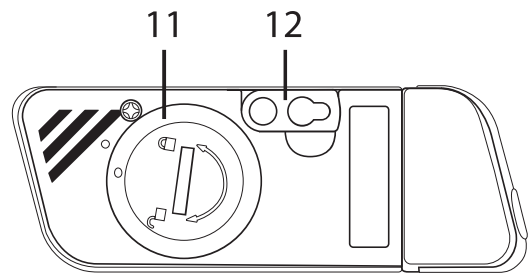
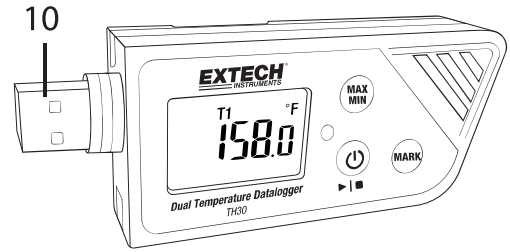

5. Status LED indicator (red/green). Refer to the Status LED Indicator Description later in this section.
6. MAX-MIN button. Refer to the Button Descriptions later in this section.
7. Sensors (Thermistor internal air temperature and capacitive RH sensor)
8. Power and Datalog Start/Stop button. Refer to the Button Descriptions later in this section.
9. MARK/Battery life button. Refer to the Button Descriptions later in this section.
10. USB plug
11. Battery compartment (CR2032 x 2) on rear
12. Wall hanging mount (rear). Mounting screw supplied.



## Button Descriptions

 **POWER button.** Short press to power ON or OFF. Note that the datalogger cannot be switched OFF while datalogging is in progress.

 **START/STOP button** (same physical button as the Power button above). Press and hold for 5 seconds to start or stop the datalogger. Note that the datalogger will not start unless it has been configured using the 'PDF Logger Configuration Tool.exe' program as described later in this user manual.

 **Maximum-Minimum Reading button.** At any time, short press to step through the highest (MX) and lowest (MIN) readings recorded in the current datalogging session.

 **Bookmark button.** Manually place a time-stamped 'bookmark' in the datalog report by pressing and holding the button until the displayed measurement flashes 3 times. Up to eight (8) bookmarks can be saved.

**Battery Status Note:** Short press the **MARK** button to display the approximate number of days remaining for the battery life.

## Display (LCD) Description



|   |  |
|---|--|
| <b>°F °C</b>  | Temperature unit of measure as programmed by the user  |
| <b>RH%</b>  | Displayed when showing Relative Humidity reading (RHT30)   |
| <b>T1</b>   | Represents the internal sensor (air) temperature (TH30)  |
| <b>T2</b>   | Represents the external probe temperature. If no probe is connected, the display will show dashes for the T2 temperature reading (TH30)  |
| <b>H</b>  | High Alarm triggered   |
| <b>L</b>  | Low Alarm triggered  |
| <b>REC</b>  | <b>REC</b> flashes once per second when actively datalogging. When logger is programmed with a 'Start Delay', <b>REC</b> is displayed but does not flash until after the delay time has elapsed and the logging begins |
|  | Battery icon flashes once per second when battery level is critically low  |
| <b>MX</b>   | Displayed when the maximum recorded reading is selected with the MAX-MIN button  |
| <b>MN</b>   | Displayed when the recorded minimum (MN) reading is selected with the MAX-MIN button   |

## LED Status Indicator Description

The dual color (red/green) LED status indicator is located to the right of the LCD.

- Red (Alarm): Blinks red every 10 seconds in an alarm condition
- Green (Datalogging): Blinks green every 10 seconds while actively datalogging
- Green (PC connection): Glows steady green while establishing connection to PC

## PDF Logger Configuration Tool

Connect the datalogger to PC USB port. The PC will prompt to view files. Open the 'PDF Logger Configuration Tool' from the list of available files. Refer to the Operation Section for additional details on this tool:

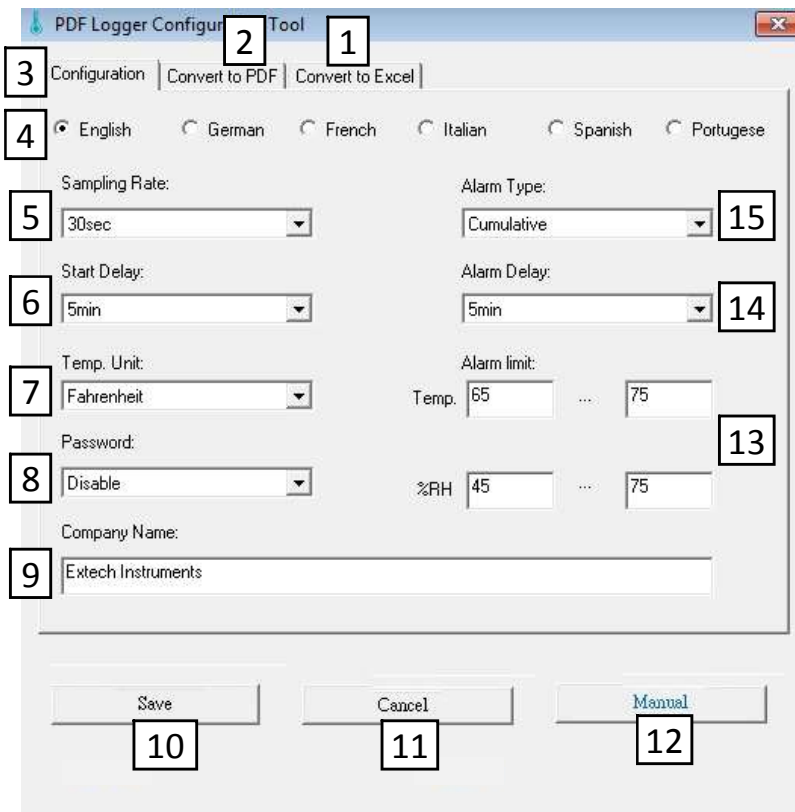

1. CONVERT TO EXCEL: Create a spreadsheet report of the logged data
2. CONVERT TO PDF: Create a PDF report and a trend graph of the logged data
3. CONFIGURATION: Click to configure the logger
4. LANGUAGE SELECTION
5. SAMPLING RATE: Datalogger recording interval
6. START DELAY: Delay period from when START is pressed and datalogging begins
7. TEMP. UNIT: Temperature unit selection (°C/°F)
8. PASSWORD: Select a 16-character password for tamper protection
9. COMPANY NAME: 20-Character user label for inclusion in logging report
10. SAVE: Press SAVE to confirm the configuration
11. MANUAL: Open the supplied PDF User Manual
12. CANCEL: Abort the configuration
13. ALARM LIMIT: Select the RH% and Temperature low/high alarm limits. Note that for the TH30, RH% is replaced by external temperature probe alarm limit
14. ALARM DELAY: Datalogger will ignore alarms for the programmed period of time
15. ALARM TYPE: Select Alarm mode

# Operation

---

## NOTES:

1. Adobe Reader® software is required.
2. Ensure the logger is at room temperature before inserting it into a PC port.
3. The executable file for programming is named "PDF Logger Configuration Tool".
4. A datalogging session cannot start until the datalogger is properly configured.

## Configuring the TH30 and RHT30 for a Datalogging session

At any time before logging is started, the logger can be programmed and re-programmed. The previous logging session will be deleted once a new session is started.

1. Connect the data logger to a PC via the USB port. The logger will switch ON automatically. Note that a short press of the power button  will also power the logger.
2. The LED will glow green while a connection with computer is being established.
3. An AutoPlay prompt will appear on the PC when communication is established.
4. Click on 'Open folder to view files' to see the available files.

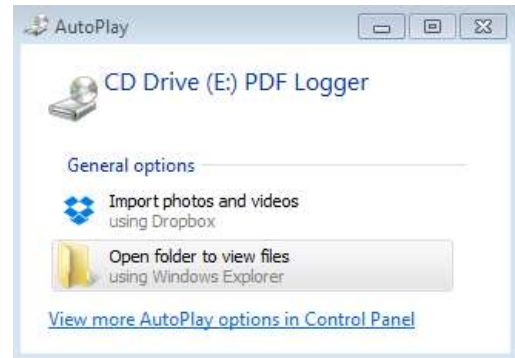

Open the program "PDF Logger Configuration Tool.exe".

5. The default language is English; select German, French, Italian, Spanish, or Portuguese as desired. The generated logging report format will match the language selected.
6. To review the User Manual, click 'Manual' to open the User Manual PDF file.
7. The parameters needed to configure the datalogger for logging are defined below. Refer to the earlier screen shot of the 'PDF Logger Configuration Tool' window for reference:

- **Datalog Sampling Rate**

Select the datalogging sampling rate (recording interval) from 30 seconds ~ 120 minutes. The default setting is 30 seconds.

- **Datalog Start Delay**

Select a period of time that must elapse before recording can begin after the Start/Stop button  is pressed (select from 0 min to 24 hours). The default setting is 0 minutes.

- **Temperature Unit of Measurement**

Select the temperature unit °C or °F.

- **Alarm Delay**

The preset alarm delay time for the **Single Event Alarm** mode is always zero. The adjustable delay time range for the **Cumulative Alarm** is 5 ~ 120 minutes.

- **Alarm Modes**

Single Event Alarm mode: The LED immediately starts flashing red every 10 seconds when the measured value exceeds the alarm threshold.

Cumulative Alarm mode: The LED begins flashing red only after the *average value* exceeds the alarm threshold and also after any programmed Alarm Delay time. See Alarm Delay parameter above.

Alarm Disable (default): Alarm function disabled.

Alarm Note: The LED will continue flashing red every 10 seconds (once it is triggered by an alarm) even when the measurement later returns to the normal range. To stop the LED alarm, plug the logger into the PC USB port to generate a report, or power off the logger (short press of the power button while it is not connected to the PC).

- **Alarm Limits**

Select the alarm threshold ranges for air and external probe temperature (TH30) or air temperature and RH% (RHT30). For example, if the external probe temperature range is set to 2.0~8.0 °C, when the measurement falls below 2°C or exceeds 8 °C the LED will flash red every 10 seconds.

**Note**: If an alarm occurs between two logging points, the logged data will not show the alarm but the LED may still flash red every 10 seconds, especially in Single Event alarm mode. If desired, use the Cumulative Alarm mode to minimize this effect.

- **Password**

A 16 alphanumeric character (max.) password may be used to prevent unauthorized re-programming.

- **User Company Name**

Input a company name to be included on the log report (20 characters max.).

- **A Note On Time Zones**

The logger automatically synchronizes the time zone with the connected PC when 'SAVE' is selected. Note: Time zone changes occurring during logging are not taken into account.

Once all the programming is complete, press 'SAVE' to confirm the settings. Close the setup window, remove the logger from the PC USB port, and start datalogging as described in the next section.

## Start Datalogging

1. Configure the logger as previously described and then hold the Start/Stop ►|■ button for 5 seconds to start logging.
2. Measurements update on the display every 10 seconds. For the RHT30 the temperature and RH% displays toggle every 5 seconds.
3. If the logger is programmed with a Start Delay: After pressing and holding the Start/Stop button for 5 seconds to start logging, **REC** will appear on the LCD but will not flash until the delay time has elapsed and logging has begun.
4. When the datalogger is successfully running, the LED flashes green every 10 seconds (as long as there is no alarm).

### Monitoring Alarms While Datalogging

The LED will flash RED every 10 seconds when there is an alarm. The display also shows 'L' for low alarm and 'H' for high alarm. To stop the LED from flashing red, plug the logger into a PC, or power off (short press of the power button).

### Placing 'Bookmarks' While Datalogging

To place a bookmark manually during datalogging, press and hold the **MARK** button until the measured reading flashes 3 times. Up to eight (8) bookmarks can be placed; the bookmarks will appear in the logging report.

### MAX-MIN Readings

Short press the **MAX-MIN** button to step through the highest (MX) and lowest (MN) readings stored in memory.

### Checking Battery Status

At any time, short press the **MARK** button to view the approximate number of days remaining for battery life. If battery power is critically low, the battery icon will blink once per second on the LCD display.

## Downloading Logged Data (PDF and Spreadsheet Datalog Reports)

1. Press and hold the Start/Stop ►|■ button for 5 seconds to stop the datalogger.
2. Plug the logger into the PC USB port (this also stops the datalogger).
3. Open the 'PDF logger Configuration tool' from the list of available files.
4. Choose 'Convert to PDF' or 'Convert to Excel' to generate a report.
5. Select the PC file location where the report is to be saved.
6. The PDF report includes the recorded data, bookmarks, and a trend graph. The spreadsheet report contains the same data as the PDF report minus the trend graph.



# Specifications

---

|                               |   |
|-------------------------------|---|
| Display (LCD)                 | 5-digit LCD with multi-function indicators  |
| Status indicator (LED)        | Dual color multi-purpose LED (red/green) for active logging, alarms, and PC connection status                             |
| Temperature Sensors           | NTC Thermistors (TH30/RHT30 internal temperature sensors and TH30 external temp. probe)                                   |
| Ext. Temperature probe length | 2.1m (84") (TH30)   |
| Temperature range             | -30 ~ 70°C (-22 ~ 158°F) internal and external probes   |
| Temperature resolution        | 0.1°C/°F  |
| Temperature Accuracy          | ±0.5°C (0.9°F) for internal and external (TH30) probe   |
| Humidity Sensor               | Capacitive (Relative Humidity) RHT30 only   |
| Humidity range                | 0.1 ~ 99.9%RH   |
| Humidity resolution           | 0.1%RH  |
| Humidity Accuracy             | ±3% at 25°C (10 ~ 90%RH), ±5% all other ranges  |
| Logger Type                   | Re-usable   |
| Datalogger capacity           | TH30: 24000 air temperature/24000 external probe temp. readings<br>RHT30: 24000 temperature/24000 humidity (RH%) readings |
| Sampling intervals            | 30 seconds and 5, 10, 30, 60, 90, 120 minutes   |
| Start delay time              | 0, 5, 30, 45, 60, 90, 120 minutes, and 24 hours   |
| Alarm ranges                  | Temp: -30~70°C (-22~158°F); Humidity: 1 to 99%RH  |
| Alarm delay (inhibit)         | 0, 5, 30, 45, 60, 90, 120 minutes   |
| Alarm types                   | Single Event, Cumulative, and Disable   |
| Operation Buttons             | Power/Start-Stop, MARK, MAX-MIN   |
| Operating temperature         | -30~70°C (-22~158°F) for logging; Allow logger to return to room temperature before connecting to PC                      |
| Operating Relative Humidity   | < 80% RH  |
| Storage temperature           | -40~85°C (-40~185°F)  |
| Storage Humidity              | < 90% RH  |
| Dimensions                    | 80 (L) x 43 (W) x 2.5 (D) mm (3.2 x 1.7 x 0.1")   |
| Weight                        | 90g (3.2 oz.)   |
| Battery                       | Two (2) 3.0V CR2032 batteries (pre-installed)   |
| Battery life                  | Three (3) months  |
| Safety Compliance             | CE  |
| Warranty                      | One Year  |

# Maintenance

## Battery Replacement

The battery compartment is located on the back of the datalogger as shown in the Descriptions section. When the battery symbol flashes on the display, replace the batteries promptly.

1. Using a large coin, rotate the battery compartment lid **clockwise** approximately one quarter turn to open the compartment
2. Replace the two (2) CR2032 batteries with positive (+) side facing up
3. Replace the battery compartment lid and turn **counterclockwise** to secure it
4. Dispose of batteries in accordance with country, state, and local regulations



Never dispose of used batteries or rechargeable batteries in household waste. As consumers, users are legally required to take used batteries to appropriate collection sites, the retail store where the batteries were purchased, or wherever batteries are sold.

**Disposal:** Do not dispose of this instrument in household waste. The user is obligated to take end-of-life devices to a designated collection point for the disposal of electrical and electronic equipment.

## Battery Status Check

To check the approximate number of days of battery life remaining, short press the **MARK** button. The display will show the number of days and the 'd' for days (XXd).

## Cleaning

Wipe the datalogger with a damp cloth, do not use solvents or abrasives as these may damage the datalogger finish and display lens.

## Error Display Codes

| ERROR           | CAUSE                                | SOLUTION   |
|-----------------|--------------------------------------|--|
| Dashes<br>----- | External probe unplugged (TH30 only) | Check the connection between the external probe and logger |
| E02             | Measured value below specified range | Operate in the specified range                             |
| E03             | Measured value above specified range | Operate in the specified range                             |
| E04             | Temperature error (RHT30 only)       | Contact Extech for service                                 |
| E11             | Humidity check failed (RHT30 only)   | Contact Extech for service                                 |
| E31             | Microprocessor failed                | Contact Extech for service                                 |
| E33             | Humidity measurement error           | Contact Extech for service                                 |

**Copyright © 2016 FLIR Systems, Inc.**

All rights reserved including the right of reproduction in whole or in part in any form

**www.extech.com**