



Pocket Pump TOUCH Sample Pump

Cat. No. 220-1000 Series

Operating Instructions

863 Valley View Road, Eighty Four, PA 15330 USA • Tel: 724-941-9701 • www.skcinc.com



Figure 1. Pocket Pump TOUCH Physical Feature Overview

Table of Contents

Introduction 2	Maintenance 24
<i>Checking Pump Kit/Contents</i>	<i>Change the Battery Pack</i>
	<i>Clean the Touch Screen</i>
Quick Guide 2	
Getting Started 3	Troubleshooting 24
<i>Charging the Battery Pack</i>	Accessories/Replacement Part Ordering 25
<i>Battery Charging Notes and Cautions</i>	SKC Limited Warranty and Return Policy 25
<i>Turning Pump Power On/Off</i>	Appendix: Performance Profile 26
<i>Interpreting the Display</i>	
<i>Determining Battery Charge Status</i>	
<i>Using the Touch Screen</i>	
<i>Navigating Menus and Screens</i>	
<i>Determining Pump Status</i>	
<i>Modifying Device Settings</i>	
(Clock Menu: Date/Time, Units Menu: Display Units, Screen Menu: Dim/Security)	
Operation (Sample Menu: Set Flow, Calibrate, and Sample) 13	
To set pump flow rate	
To set up a single sorbent tube train and calibrate – Constant Flow Mode	
To set up a multiple sorbent tube train and calibrate – Constant Flow Mode	
To set up a multiple sorbent tube train and calibrate – Constant Pressure Mode	
To calibrate pump flow rate prior to bag sampling – Constant Flow Mode	
To sample using a single sorbent tube, multiple sorbent tubes, or sample bag	
To set up and run a manual sample	
To set up and run a timed sample	
To run a sample preset	
<i>Flow Fault Mode and Display</i>	
<i>Viewing History</i>	
<i>Using Pocket Pump TOUCH with DataTrac Pro for Pocket Pump TOUCH Software</i>	

Introduction

Checking Pump/Kit Contents

Use the following table to verify that you received all items associated with the Cat. No. ordered. If you are missing items, contact SKC at 800-752-8472 (U.S. only) or 724-941-9701.

If you ordered Cat. No.	Your Package Should Contain
220-1000TC	Pocket Pump TOUCH only* with Li-Ion battery and screwdriver, requires charger; <i>see kits or charger below</i>
220-1000TC-C	Pocket Pump TOUCH with Charger* includes pump as described above and single charger (cable and wall cube with U.S. plug) 100-240 V
220-1000TC-S	Pocket Pump TOUCH Starter Kit* includes pump and single charger as described above, 3 feet (0.9 meter) of Tygon tubing, and collar clip with cable tie 100-240 V
220-1000TC-K	Single Pump Kit** includes pump and single charger as described above, and Type A single tube holder, in a soft-sided nylon carry case 100-240 V
220-1000TC-K5	5-pack Pump Kit* includes 5 pumps as described above, 5 single chargers (cables and wall cubes with U.S. plug), and 5 Type A single tube holders, in a Pelican case 100-240 V
220-1000TC-K5D	5-pack Deluxe Pump Kit* includes 5 pumps as described above, 5 Type A single tube holders, 5 single charging cables (no wall cubes), one 5-port USB charging hub with power cable (U.S. plug), and 1 DataTrac Pro USB Bluetooth Adapter (software available via free download), in a Pelican case 100-240 V

Pocket Pump TOUCH requires ¼-inch ID tubing.

* Pocket Pump TOUCH pumps contain Li-Ion batteries and are subject to special shipping regulations.

† Single kits are also available in hard-sided Pelican case. Contact SKC.

Quick Guide

Charging the battery: Insert USB connector on cable into USB port on supplied wall adapter. Plug into 100 to 240-V outlet. Hover magnetic charging connector on cable closely over contact on back of pump until engaged and LEDs on contact and cable light blue. Full charge is achieved in approximately 10 hours. *See Charging the Battery Pack on page 3 for details.*

Turning on: Press Power On/Off button on top of pump; the screen will light and Flow screen will display.



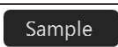
Using the touch screen: Use a fingertip to gently touch screen buttons in the indicated active zones.

Accessing Main Menu: Touch .



Active Touch Screen Areas

Navigating from Main Menu

Desired Operation	Button to Touch	Result
Access device settings		History, Clock, Units, and Screen sub-menus display. Touch buttons to view and choose setting options within each.
View information about the pump		Firmware version/date of pump manufacture, and pump serial number display.
Access flow rate, calibration, and sampling		Flow, Presets, and Advanced (constant pressure) sub-menus display. Touch buttons to view and choose mode or options under each.

Basic Pump Operation

Run pump: From Main Menu: Touch Sample >Flow >Run .

Note: Pressing the Power On/Off button on top of pump will dim and lock screen. To undim and unlock, press Power On/Off button again.

Pause pump: Touch Pause . Touch Run  to resume.

Stop pump: Touch Stop . Sample Summary will display. Touch  to return to Main Menu.

Turning off: Press Power On/Off button on top of pump; the screen will go dark. The pump will power off automatically after five minutes of no activity.

Getting Started

Charging the Battery Pack

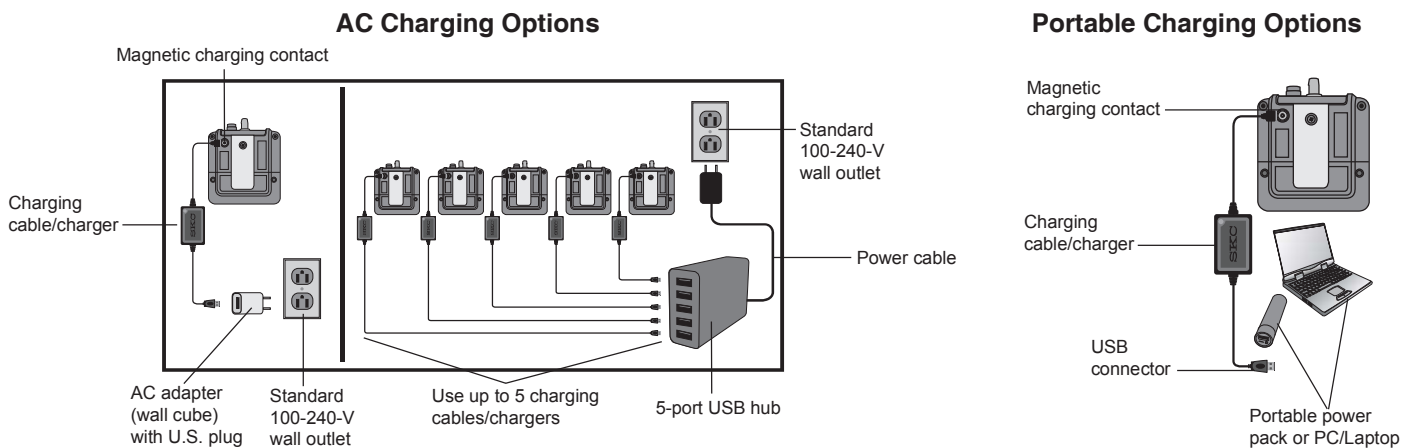


Figure 2. Charging Trains

1. Insert USB connector on charging cable into a USB port on a(n):
 - a. **Adapter** (wall cube, supplied with SKC Single USB Charger, Cat. No. 220-300). Plug adapter (wall cube) into a standard 100 to 240-volt wall outlet.
 - b. **PC/laptop** (not supplied by SKC) with a full charge or plugged into a wall outlet. **Note:** USB ports and PC/laptop settings vary. If using this charging option, verify that your pump is charging by checking that more bars have appeared on the pump battery status icon midway through charging.
 - c. **Portable power pack** (not supplied by SKC) with a full charge and that is compatible with Pocket Pump TOUCH

The blue LED on the charger will light.

2. Hover the magnetic charging connector on the charging cable closely over the charging contact on the back of the pump (*Figure 1*) until the LED behind the magnetic contact on the pump lights blue and pump status LEDs blink red in a repeating pattern of right-inlet-left.

Troubleshooting Charging

If the magnetic charging connector is seated on the pump charging contact, but the charger and charging contact LEDs are not lit blue: Check that the charging cable is connected to an AC adapter and active outlet, PC/laptop connected to an active power source, or a portable power pack with a full charge that is compatible with charging Pocket Pump TOUCH.

If only the charger LED lights blue: It means that there is no connection with the pump charging contact. Check and reconnect the charging connector on the cable to the pump's charging contact. Both the charger and charging contact LEDs should light blue when connected properly.

3. Charge battery completely (approximately 10 hours to 100% or 4.5 hours to 80%). See battery charge status indicator descriptions below.

LED Activity Description	Charging Status
Charging contact LED blue/inlet and corner LEDs red, flashing in repeated pattern of right-inlet-left	Battery charging
Charging contact LED blue/inlet LED green, solid/corner LEDs green, blinking, battery status icon outline flashing	Battery charging complete

Battery and Charging Notes and Cautions

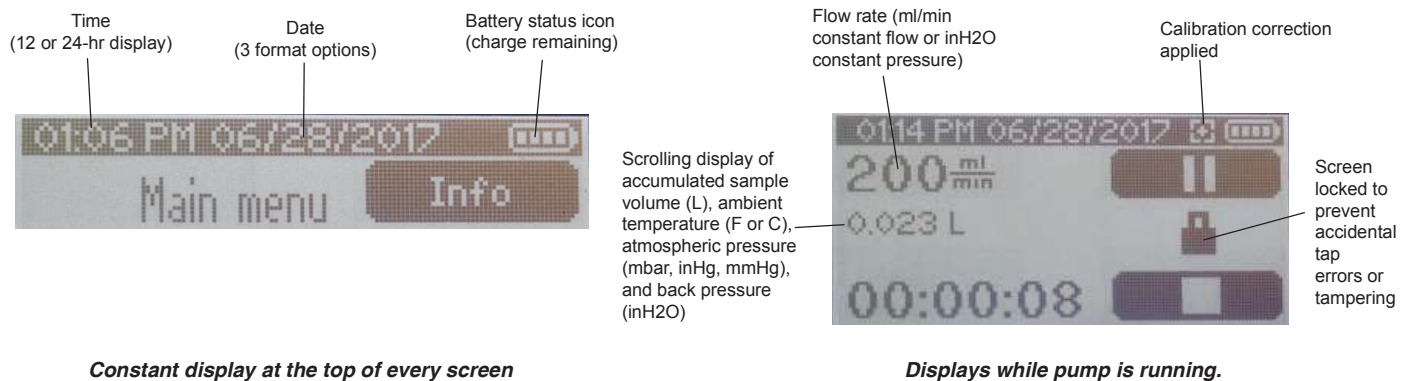
- Do not operate pump from or charge pump with charger in hazardous atmospheres.
- Use only the SKC-approved battery pack (Cat. No. P76303) and charging cable supplied in Cat. No. 220-300. Use of an unapproved battery and/or charging cable could damage the pump and will void any warranty.
- Turn off pump before removing the battery pack.
- Tampering with the battery pack (opening, disassembling, short circuiting, crushing, or exposing the battery pack to fire or temperatures in excess of 212 F [100 C]) voids any warranty.
- Protect sample pump from rain and extended direct exposure to sun when in use outdoors
- Allow pump to equilibrate when moving it from one temperature extreme to another.
- Failure to follow warnings and cautions voids any warranty.
- Substitution of components may impair intrinsic safety. La substitution de composants peut compromettre la Sécurité Intrinsèque.
- To prevent ignition of hazardous atmosphere, batteries must only be charged (removed and replaced) in an area to be known nonhazardous. Afin de prévenir l'inflammation d'atmosphères dangereuses, ne changer les batteries que dans des emplacements désignés non dangereux.
- Maximum charge input voltage $U_m = 5.5$ VDC.
- The battery used in this device may present a risk of fire or explosion when heated above 212 F (100 C) or incinerated. Replace battery with SKC Battery Pack Cat. No. P76303 only. Use of another battery may present a risk of fire or explosion.

Turning Pump Power On/Off

Turn on: Press the Power On/Off button on the top of the pump (*Figure 1*); the screen will light.






Turn off: Press the Power On/Off button on the top of a non-running pump (*Figure 1*); the screen will go dark. The pump will automatically power off after five minutes of inactivity.

Interpreting the Display



Determining Battery Charge Status

The battery status icon appears at the top of the screen at all times and contains bars that reduce in number as battery charge is used. Following is information on interpreting the battery status icon.

Battery Status Icon Description	Battery Charge Remaining
Four bars 	Full battery charge, approximately 75 to 100%
Three bars 	Approximately 50 to 75%
Two bars 	Approximately 25 to 50%
One bar 	Approximately 3 to 25%
One bar (flashing) 	Less than 3%; flow fault is imminent. Pump should be charged.

Using the Touch Screen

Use a fingertip to gently touch screen buttons in the active zones indicated below.







Navigating Menus and Screens

Pocket Pump TOUCH operates through a series of menus and screens. When the pump is powered on, the Flow screen displays, which allows you fast access to calibration and sampling. For more details, start at *To set pump flow rate*.

Immediately below the display are four virtual navigation buttons that access previous screen, Main Menu, and increase/decrease values.



Back button	Up Arrow button	Down Arrow button	Main Menu button
Returns to previous screen	Increases selected value or moves up a list/range/display	Decreases selected value or moves down a list/range/display	Returns to Main Menu
			
	Touch and hold to speed increment of flow or pressure settings.	Touch and hold to speed decrement of flow or pressure settings.	

Touching  displays the Main Menu from which you can access all options. Following is a Menu/Screen Overview.

Menu/Screen Overview

Main Menu

Device

History Menu

- List of sample runs/summaries

Clock Menu

- Set Time
- Set Date
- Select Clock display
- Select Date display

Units Menu

- Select Temp display
- Select ATM display

Screen Menu

- Select Dim
- Select Secure Lock
- Select Auto Lock

Info

- Firmware version number
- Lifetime run time and volume
- Pump serial number
- Pump manufacture date

Sample

Flow Menu

- Set Flow
- Calibrate (constant flow mode)
- Set Duration (timer)
- Run button



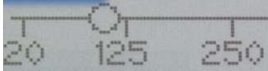




Presets Menu

- Select presets P1-P4 (created in DataTrac Pro, uploaded to pump)

Advanced Menu

- Set Pressure
- Set Duration (timer)
- Run button

Menus and screens can contain the following navigational touch buttons.

Button	General Function
Check mark 	Saves a selected item
Left and right movement 	Allows horizontal movement on a scale (<i>see right</i>) or moves left or right through fields, activating each for entry of a value. 
Calibration/Flow Adjustment 	Allows selection of an adjustment to flow during calibration
Run (start) 	Runs the pump for sampling
Pause 	Pauses a running pump. Elapsed time and volume accumulation pause. When Run is touched, time and volume will continue to accumulate.
Stop 	Stops a running pump and resets elapsed time and volume to zero. Run time information will be available in Sample Summary and History.

Determining Pump Status

Pocket Pump TOUCH features status LEDs on the top corners of the pump, beneath the pump inlet, and behind the magnetic charging contact on the back of the pump. These indicate pump status at a quick glance.

LED Activity Description	Pump Status
Corner and inlet LEDs green, flashing	Pump running
Corner and inlet LEDs red, flashing	Pump is in flow fault
Inlet LED yellow-orange, flashing corner LEDs green, blinking	Pump in constant pressure mode, working to achieve pressure setting. Inlet LED will change to solid green when set pressure is achieved.

Modifying Device Settings

Note about default settings: Pocket Pump TOUCH is shipped with the following default settings that may be changed by the user from the Device sub-menus.

Dim: On, Auto Lock: Off, Secure Lock: Off, Temperature Units: F, Atmospheric Pressure Units: inHg, Time Format: 12 Hour, and Date Format: mm/dd/yyyy

Clock Menu

To change time on pump

From Main Menu:



Touch Device



> Touch Clock



> Touch time displayed



Hour digits will flash.

Touch up/down arrow buttons to increment/decrement hours.

Touch right arrow to advance to minutes (will flash) and up/down arrow buttons to adjust minutes.

Touch right arrow to advance to AM/PM (will flash) and up/down arrow buttons to toggle AM/PM.



Touch check mark to accept new time and return to Clock Menu. New time setting will display.

To change clock display format

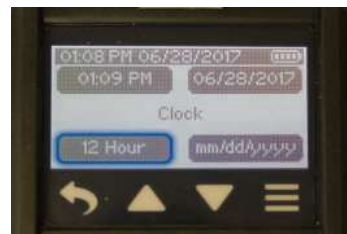
From Main Menu:



Touch Device



> Touch Clock



> Touch 12 or 24 Hour



12 Hour and 24 Hour buttons display. Touch desired setting button to select and return to Clock Menu. New clock display format will display.

To change date and date display

From Main Menu:



Touch Device



> Touch Clock



> Touch Date



Month digits will flash.

Touch up/down arrow buttons to increment/decrement month.

Touch right arrow to advance to day (will flash) and up/down arrow buttons to increment/decrement day.

Touch right arrow to advance to year (will flash) and up/down arrow buttons to increment/decrement year.



Touch check mark to accept new date and return to Clock Menu. New date will display.

To change date display format

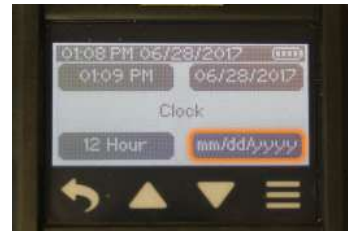
From Main Menu:



Touch Device



> Touch Clock



> Touch Date Display Format



Touch the desired date display format to select and return to Clock Menu. New date display format will display.

Units Menu

To change temperature units

From Main Menu:



Touch Device



> Touch Units



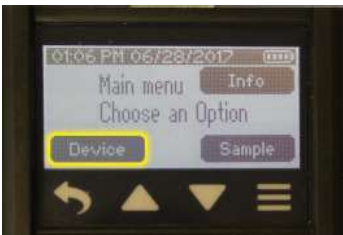
> Touch Temp



°F and °C buttons display. Touch desired button to select and return to Units Menu.

To change atmospheric pressure display units

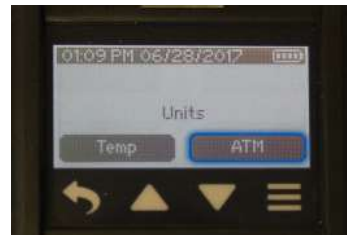
From Main Menu:



Touch Device



> Touch Units



> Touch ATM



mbar, inHg, and mmHg buttons display. Touch desired button to select and return to Units Menu.

Note: Changing the display units affects only the display of **atmospheric pressure** on the pump screen and in Sample Summary and History. **Back pressure** (inlet pressure) will always display in "inH2O" on the pump screen and in Sample Summary and History.

Screen Menu

To set Dim to on or off

From Main Menu:



Touch Device



> Touch Screen



> Touch Dim



Touch desired button to select and return to Screen Menu.

If Dim is set to **On**, the user can dim and lock the screen of a running pump by pressing the Power On/Off button. If Auto Lock is set to **On** in combination with Dim, the screen will dim and lock automatically when the pump is run. The screen can be undimmed and unlocked by pressing the Power On/Off button. *For more information on the Auto Lock and Secure Lock features, see below.* This setting helps conserve battery usage.



If Dim is set to **Off**, the screen backlight will stay on during the entire sample run.

To set Auto Lock to on or off

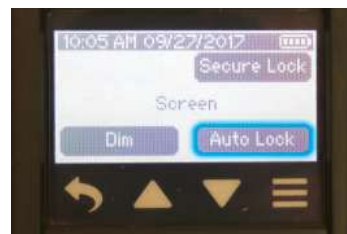
From Main Menu:



Touch Device



> Touch Screen



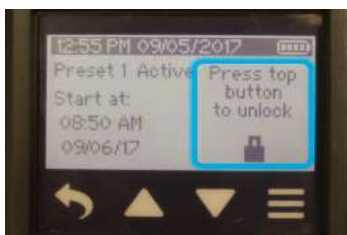
> Touch Auto Lock



Touch desired button to select and return to Screen Menu.

If **Auto Lock is set to On**, the screen will lock (become inactive) as soon as the pump starts running a sample. A lock icon and "Press top button to unlock" message will appear on the screen. If Dim is set to On, the screen will both lock and dim when the pump starts running a sample.

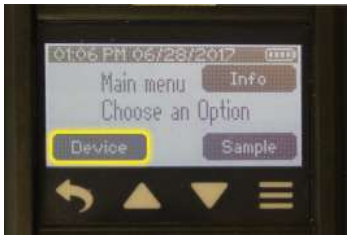
If **Auto Lock is set to Off**, the screen will remain active. The screen may be locked (made inactive) **manually** at any time during a sample run by pressing the Power On/Off button on top of the pump.



To unlock and reactivate the screen, press the Power On/Off button on top of the running pump. This setting helps to prevent accidental tap errors during sample runs.

To set Secure Lock to on or off and set passcode

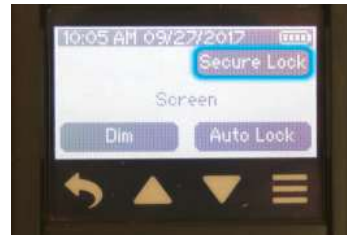
From Main Menu:



Touch Device



> Touch Screen



> Touch Secure Lock

Secure Lock helps to prevent tampering during a sample run. Touch desired button. **If Secure Lock was set previously to On and you select Off**, you will be prompted to enter the previously set passcode. Once the passcode is entered, you will be returned to the Screen Menu.



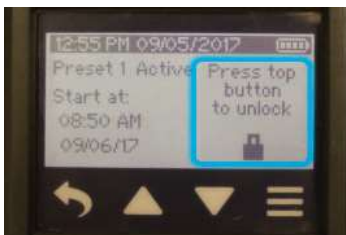
If you select **On**, proceed as follows.



You will be prompted to enter a four-digit passcode of your choosing. Touch the screen keypad to enter the desired four-digit number combination. **Note:** Entered digits will display as ****.



You will be prompted to confirm the passcode. Touch the screen keypad to enter the same four-digit number combination. Upon entering the last digit, the passcode will be saved and you will be returned to the Screen Menu.



If Secure Lock is set to **On**, the user can lock the screen of a running pump by pressing the Power On/Off button. If Auto Lock is set to On concurrently, the screen locks when the pump is run.

To unlock and reactivate the screen, press the Power On/Off button on top of the running pump and touch the screen keypad to enter the previously set four-digit passcode.

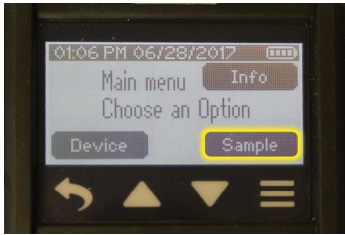
Master Unlock Feature: If you cannot remember the Secure Lock passcode, touch 1 2 3  when prompted for the passcode. This will override the Secure Lock, but will not disable it.

Operation - Set Flow, Calibrate, and Sample

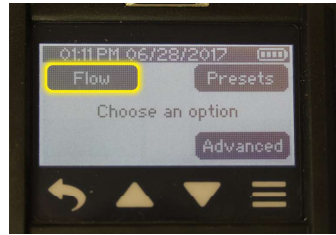
Sample Menu

To set pump flow rate

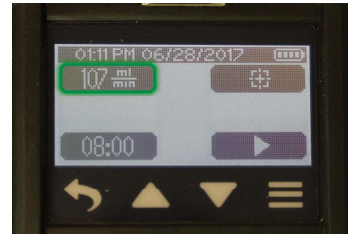
From Main Menu:



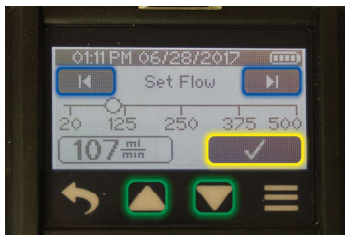
Touch Sample



> Touch Flow



> Touch flow display



Touch left/right arrow buttons to set gross flow setting. Touch up/down arrow buttons to fine tune setting.

Note: A sustained touch on the up/down arrow buttons will speed increment/decrement flow setting.

Touch check mark to accept selection and return to Flow Menu with new flow setting displayed.

To set up a single sorbent tube train and calibrate – Constant Flow Mode

- * Charge pump battery completely before calibration and sampling.
- * Requires 222 Series Low Flow Holder accessory.
- * Calibrate/verify pump flow rate before and after each sampling operation using the tube holder and pump to be used for sampling.

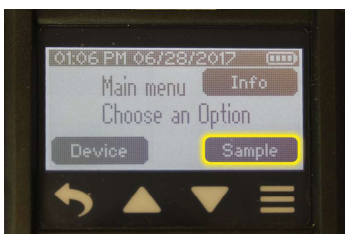
1. Break tips off a representative sorbent tube and insert (arrow printed on tube pointing toward the pump) into the rubber sleeve of a 222 Series (non-adjustable) Low Flow Tube Holder (Figure 3).
2. Connect tubing from the 222 Series (non-adjustable) low flow tube holder to the pump inlet (Figure 3).
3. Use a length of flexible tubing to connect the exposed open end of the representative sorbent tube in the holder to a calibrator outlet (Figure 3).
4. Set flow rate on pump (see To set pump flow rate above).
5. Calibrate flow rate as follows:

Pump inlet → 222 Series (non-adjustable) Low Flow Tube Holder → Sorbent tube → Tubing → Calibrator outlet

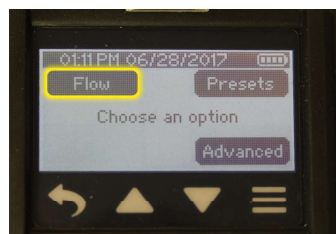


Figure 3. Single-tube Calibration Train Overview

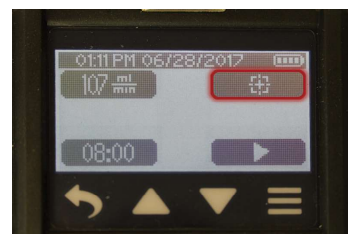
From Main Menu:



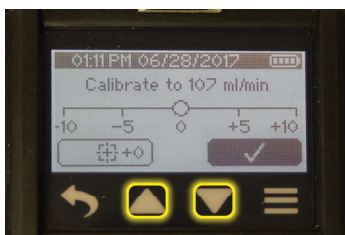
Touch Sample



> Touch Flow



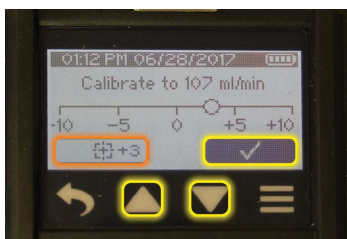
> Touch calibration icon



Pump will run as a result of touching the calibration icon. It is good practice to allow the pump to run for 5 minutes before calibrating the flow rate.

Build a calibration train with sample media in line (Figure 3).

Touch up/down arrow buttons to increment/decrement calibration adjustment.



The **calibration adjustment value will display** beside the calibration icon.

Note: The flow rate displayed on the calibrator will change as a result of this adjustment.

Touch check mark to accept the calibration adjustment value and return to the Flow Menu.



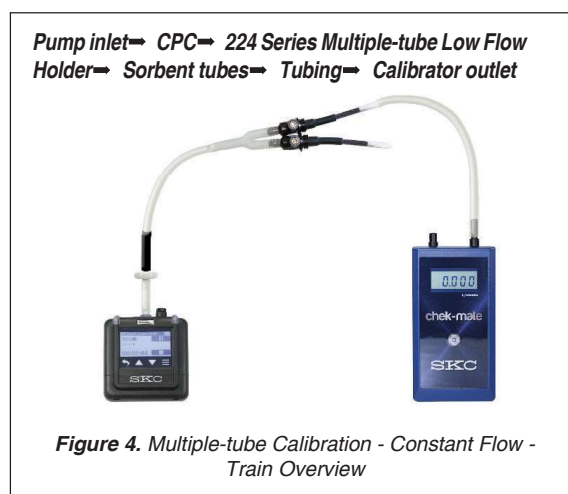
The flow rate displayed on the pump will remain unchanged.

- Disconnect representative sorbent tube from the calibrator. Replace representative sorbent tube with a newly opened unexposed method-specified sorbent tube to complete the sampling train. *See To sample on page 18.*

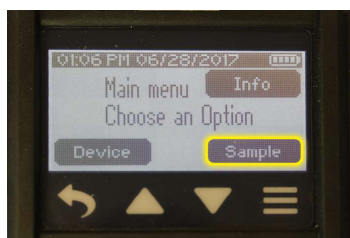
To set up a multiple sorbent tube train and calibrate – Constant Flow Mode

- * Charge pump battery completely before calibration and sampling.
- * Use of an unapproved battery and/or charging cable could damage the pump and will void any warranty.
- * Requires Constant Pressure Controller (CPC) and Multiple-tube Low Flow Holder accessories.
- * See Adjustable Low Flow Holder Operating Instructions for details on holder operation.
- * Calibrate/verify pump flow rate before and after each sampling operation using the tube holder and pump to be used for sampling.

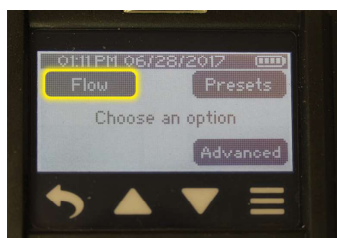
- Set flow rate on pump (*see To set pump flow rate on page 13*). **Important!** Set pump flow rate to $\geq 15\%$ higher than the sum of the flow rates through all tubes to be used during the multiple-tube sample run to ensure adequate airflow. **Note:** The combined flow through all tubes cannot exceed 500 ml/min.
- Press tubing from the outlet (unlabeled side) of a Constant Pressure Controller (CPC) onto the pump inlet (*Figure 4*).
- Press tubing from the 224 Series Multiple-tube Low Flow Holder onto the CPC inlet (labeled "To Sample" - *Figure 4*).
- Break tips off a representative sorbent tube and insert (arrow printed on tube pointing toward the pump) into the rubber sleeve of a 224 Series Multiple-tube Low Flow Holder (*Figure 4*). Repeat for additional tubes up to the maximum number of holder ports or desired number of tube samples. **Important!** Fill unused tube holder ports with unopened sorbent tubes to keep ports clean during sampling.
- Label all sorbent tubes and ports.
- On the Multiple-tube Low Flow Holder, use a small flat-head screwdriver to turn **counterclockwise** the brass flow adjust screw directly beneath the first port holding an open sorbent tube. This opens the port to airflow.
- Use a length of flexible tubing to connect the exposed open end of the first port sorbent tube to a calibrator outlet (*Figure 4*).
- Calibrate pump flow rate through the tubes as follows:



From Main Menu:



Touch Sample





> Touch Flow






- a. Touch Run button. It is good practice to run the pump for 5 minutes before calibrating the flow rate.
- b. Use a small flat-head screwdriver to turn the brass flow adjust screw beneath the port of the tube to be calibrated **counterclockwise to increase flow or clockwise to decrease flow** until the calibrator consistently displays the required flow rate for the first port sorbent tube.

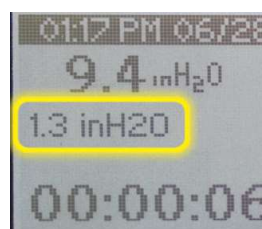
Note: The flow rate displayed on the calibrator will change as a result of adjusting the brass flow adjust screw on the holder; this is the flow rate through the sorbent tube. The flow rate displayed on the pump will **not** change.

- c. Touch the Stop button  to stop the pump. Touch the Back button  to return to the Flow Menu.
9. Repeat Steps 6 through 8 for each active sorbent tube in the holder.
 10. Disconnect representative sorbent tube from the calibrator. Replace representative sorbent tubes with newly opened unexposed method-specified sorbent tubes to complete the sampling train. **Important!** Ensure all unused ports remain plugged with unopened sorbent tubes to keep ports clean during sampling. *See To sample on page 18.*

To set up a multiple sorbent tube train and calibrate – Constant Pressure Mode
(For Advanced Users Only)

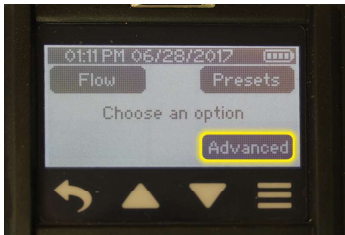
- * Charge pump battery completely before calibration and sampling.
- * Requires Multiple-tube Low Flow Holder accessory
- * See Adjustable Low Flow Holder Operating Instructions for details on holder operation.
- * It is good practice to run the pump for 5 minutes before calibrating the flow rate.
- * Calibrate/verify pump flow rate before and after each sampling operation using the tube holder and pump to be used for sampling.

1. Determine back pressure to be set in Constant Pressure Mode:
 - a. Connect tubing from holder outlet to pump inlet. (*Figure 5*).
 - b. Break tips off a representative sorbent tube and insert (arrow printed on tube pointing toward the pump) into the rubber sleeve of a 224 Series Multiple-tube Low Flow Holder.
 - c. Use a small flat-head screwdriver to turn counterclockwise (open) the brass flow adjust screw on the Multiple-tube holder port containing the tube.
 - d. Label sorbent tube and port. **Plug all unused ports with unopened tubes to keep ports clean during sampling.**
 - e. Set method-specified flow rate for the tube on the pump (*see To set pump flow rate on page 13*). **Important! Ensure all unused ports remain plugged with unopened sorbent tubes.**
 - i. Touch the Run button  to start the pump.
 - ii. Read and record back pressure shown on pump display (inH₂O part of scrolling display when pump is running – use up/down arrow buttons to speed scrolling display).
 - f. Repeat Steps 1.b through 1.e for remaining representative sorbent tubes. **Note:** The combined flow rate through all tubes cannot exceed 500 ml/min. Touch the Stop button  to stop the pump. Touch the Back button  to return to the Flow Menu.
 - g. Review the recorded back pressures and determine the highest back pressure. Add 2 or 3 inches to this value, round up to the integral (whole) number, and add 1. **This will be the back pressure setting for Constant Pressure Mode in Step 2.**

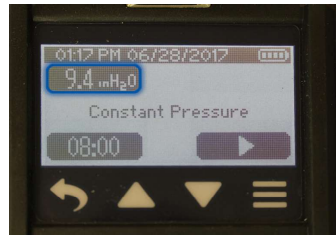


2. Set pressure to value obtained in Step 1.g as follows:

From Sample Menu:



Touch Advanced



> Touch pressure display

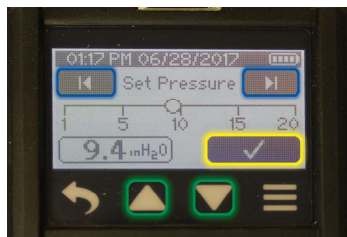



Figure 5. Multiple-tube Calibration - Constant Pressure - Train Overview

a. Touch left/right arrow buttons to set gross pressure setting. Touch up/down arrow buttons to fine-tune setting.

Note: A sustained touch on the up/down arrow buttons will speed increment/ decrement pressure setting.

Note: Set pressure value will blink and inlet LED will blink yellow-orange. When set pressure is achieved, the pressure value will stop blinking and the inlet LED will turn green. This may take up to 90 seconds.

b. Touch check mark to accept selection and return to Advanced Menu with new pressure setting displayed.

3. Use a length of flexible tubing to connect the exposed open end of the first port sorbent tube to a calibrator outlet (Figure 5).
4. Touch Run button  on the pump touch screen.
5. Use a small flat-head screwdriver to turn flow adjust screw on port (**clockwise to decrease, counterclockwise to increase**) until calibrator displays the method-specified flow rate.

Note: The flow rate displayed on the calibrator is the flow rate through the sorbent tube.

6. Repeat Steps 3 through 5 for all remaining open sorbent tubes.
7. Disconnect representative sorbent tube from the calibrator. Replace representative sorbent tubes with newly opened unexposed method-specified sorbent tubes to complete the sampling train.

Important! Ensure all unused ports remain plugged with unopened sorbent tubes to keep ports clean during sampling. See To sample on page 18.

Note: If the pump is run in constant pressure mode (Sample > Advanced > Pressure setting) without media connected or with media connected that has a pressure drop below the set pressure value, the pump will “rev ” in an attempt to achieve the desired pressure setting. If it cannot, it will fault.

To calibrate pump flow rate prior to bag sampling – Constant Flow Mode

- * Charge pump battery completely before calibration and sampling.
- * Use of an unapproved battery and/or charging cable could damage the pump and will void any warranty.

1. Set flow rate on pump (see *To set pump flow rate on page 13*).
2. Use flexible tubing to connect pump inlet to the outlet of a calibrator (Figure 6).
3. Calibrate pump flow rate as follows:

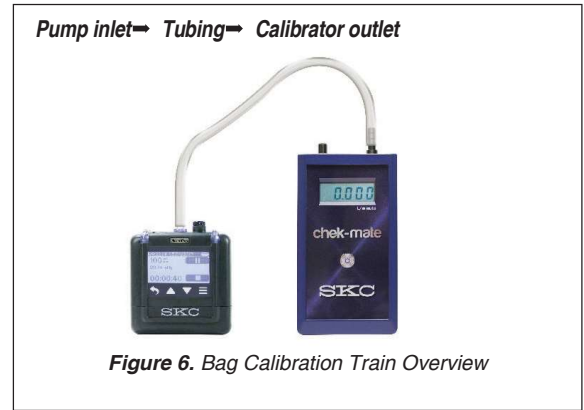
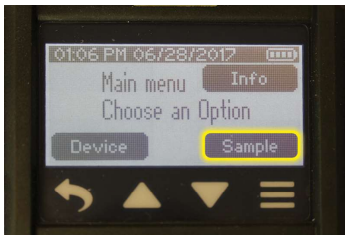
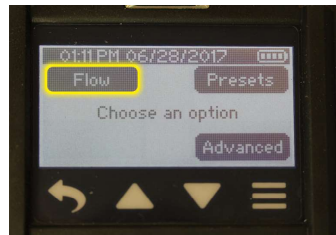


Figure 6. Bag Calibration Train Overview

From Main Menu:



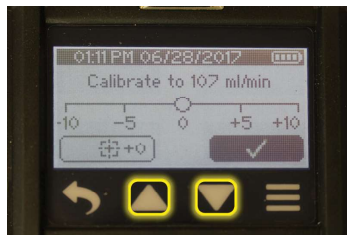
Touch Sample



> Touch Flow

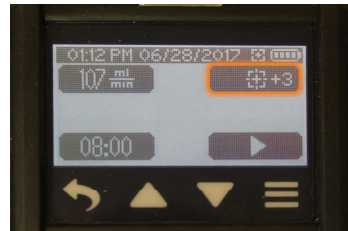
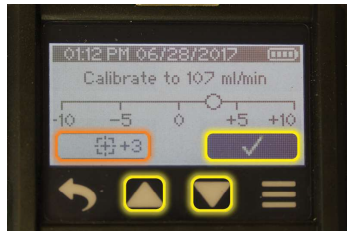


> Touch calibration icon



Pump will run. Allow pump to run for 5 minutes before performing calibration. Touch up/down arrow buttons to increment/decrement calibration adjustment. A calibration adjustment value will display, as shown below left.

Note: The flow rate displayed on the calibrator will change as a result of this adjustment. The flow rate displayed on the pump will not change.



Touch check mark to accept the calibration adjustment value and return to the Flow Menu. The calibration adjustment value will display beside the calibration icon.

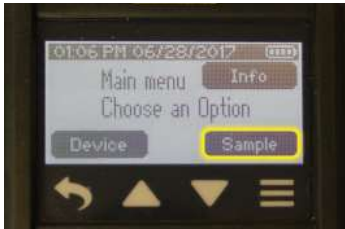
4. Disconnect calibrator and tubing from pump inlet. See *To sample on page 18*.

To sample using a single sorbent tube, multiple sorbent tubes, or sample bag

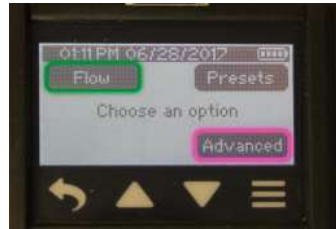
- * Charge pump battery completely before sampling.
- * Use of an unapproved battery and/or charging cable could damage the pump and will void any warranty.
- * If using sample tubes as media, calibrate/verify pump flow rate before and after each sampling operation using the tube holder and pump used for sampling.

1. Ensure pump is calibrated to the method-specified flow rate. See *To calibrate* on page 13.

From Main Menu:



Touch Sample



> Touch Flow or Advanced



> Touch Run button in Flow Menu to run pump in constant flow.

2. Ensure calibrator and tubing have been removed and representative method-specified sampling medium used for calibration has been replaced with newly opened unexposed method-specified sampling medium to complete the sampling train.



> Touch Run button in Advanced Menu to run pump in constant pressure.

For bag sampling

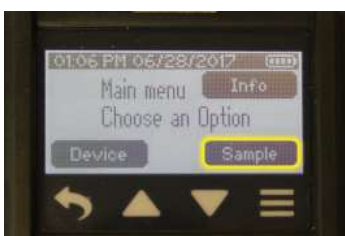
- Use PTFE tubing to **connect pump exhaust (Figure 1) to the bag fitting**. See bag operating instructions.
- Unscrew cap on pump exhaust to remove it and screw in supplied exhaust fitting or optional Quick-connect Bag Sampling Adapter accessory.
- Attach tubing from the bag to the fitting or adapter on the pump exhaust.

3. On the pump, choose from a manual sample, timed sample, or sample preset (presets are uploaded to the pump from DataTrac Pro Software). See *To set up and run a manual sample* below, *To set up and run a timed sample* on page 20, or *To run a sample preset* on page 21.

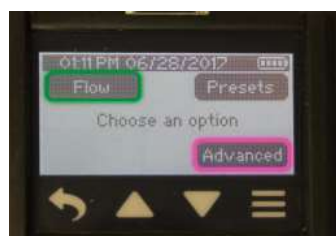
To set up and run a manual sample

- Connect pump to sampling train. See *To sample, Step 2, above*.
- Run sample as follows:

From Main Menu:



Touch Sample



> Touch Flow or Advanced




> Touch Run button in Flow Menu to run pump in constant flow.



> Touch Run button in Advanced Menu to run pump in constant pressure.

Options on pump screen during a sample run:

		<p>Touch Stop  to stop sampling, reset accumulated data display, and view Sample Summary.</p>
		<p>Touch Pause  to pause sampling and retain accumulated data display. When touched, pause changes to Run button .</p> <p>Touch Run button to resume sampling and data accumulation.</p>
		<p>Dim (set to On) dims a screen that has been locked by pressing the Power On/Off button on a running pump or through Auto Lock as soon as the pump starts running.</p> <p>To resume normal backlighting, press the Power On/Off button on top of the pump (Figure 1). See <i>Modify Device Settings, Screen Menu</i> on page 11.</p> <p>This feature may be used concurrently with Auto Lock and Secure Lock.</p>
		<p>Auto Lock (set to On) locks (inactivates) the pump touch screen when the pump starts running. A lock icon and “Press top button to unlock” message appear on the screen.</p> <p>If Auto Lock is set to Off, the screen remains active. The screen may be locked (made inactive) at any time during sampling by pressing the Power On/Off button on top of the pump.</p> <p>To unlock and reactivate the screen, press the Power On/Off button on top of the pump. This feature helps to reduce tap errors during sample runs.</p>
		<p>Secure Lock (set to On) locks (inactivates) the pump touch screen when the Power On/Off button is pressed. A lock icon and “Press top button to unlock” message appear on the screen.</p> <p>To unlock Secure Lock and reactivate the screen, press the Power On/Off button on top of the pump, and touch the screen keypad to enter the previously set four-digit passcode.</p> <p>If Auto Lock and Secure Lock are set to On concurrently, the pump touch screen will lock when the pump is run, but will require that the user enter a passcode to unlock the screen.</p>
		<p>Flow fault may occur when there is a restriction in airflow (e.g., kinked tubing) that remains uncorrected and the pump can no longer compensate flow. See <i>Flow Fault Mode and Display</i> on page 22 for details on pump operation during flow fault.</p>

- When the required sampling period is completed (or the bag is properly inflated - *see bag operating instructions*), touch Stop button  to stop sampling, which displays a Sample Summary and automatically resets the accumulated data.

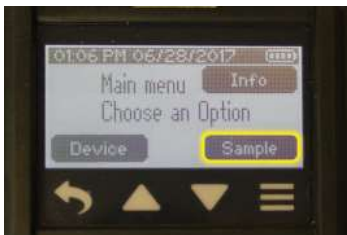
Note: If pump is shut off or goes to sleep after a sample is completed and is powered on again, the initial display will be the Sample Summary of the previous sample run.

For bag sampling: If the Quick-connect Bag Sampling Adapter accessory was used, remove tubing after sampling by using fingertips to press center ring on adapter while pulling tubing away from the adapter.

To set up and run a timed sample

- Set sample duration as follows:

From Main Menu:



Touch Sample



> Touch Flow or Advanced



> Touch Time button in Flow Menu to set sample duration.



> Touch Time button in Advanced Menu to set sample duration.



Hour digit 1 will flash.

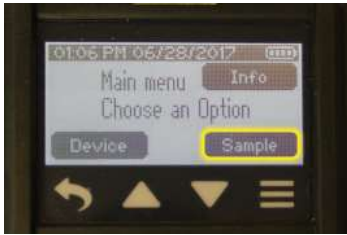
Touch up/down arrow buttons to increment/decrement hour.

Touch right arrow to advance to hour digit 2 (will flash) and up/down arrow buttons to adjust hour digit 2. Repeat through minutes.

Touch check mark to accept new time and return to Clock Menu. New time setting will display.

- Connect pump to sample train. *See To sample, Step 2, on page 18.*
- Run sample as follows:

From Main Menu:



Touch Sample



> Touch Flow or Advanced



> Touch Run button in Flow Menu to run pump in constant flow.



> Touch Run button in Advanced Menu to run pump in constant pressure.

See Options on pump screen during a sample run on page 19.

- When the Timed sampling period is complete, the pump will automatically stop sampling, which displays a Sample Summary and automatically resets the accumulated data.

Note: If pump is shut off or goes to sleep after a sample is completed and is powered on again, the initial display will be the Sample Summary of the previous sample run.

To run a sample preset (uploaded to pump from DataTrac Pro Software)

- Connect pump to sampling train. See To sample, Step 2, on page 18.
- Select sample preset as follows:

From Main Menu:



Touch Sample



> Touch Presets



> Touch desired Preset (programmed in DataTrac Pro Software and uploaded to pump)

Presets are created by the user in DataTrac Pro for Pocket Pump TOUCH Software and uploaded to the pump (see DataTrac Pro for Pocket Pump TOUCH User Manual for details on creating presets). The start date for a preset with delayed start can be changed on the pump by touching the date on the Preset screen. The pump can also be calibrated from this screen.



To run a preset sample with a delayed start, touch check mark to activate the preset.



Note: The day of a preset with delayed start can be changed from the pump screen. Touch the delayed start date, touch the up and down arrow buttons to change to desired start day, and touch check mark. This can be changed to a future day only.



The pump will display a screen showing a summary of the preset and a Cancel (X) button. Touch the X if you wish to cancel the activated preset.



To run a preset sample without a set delayed start, touch the Run button .

See Options on pump screen during a sample run on page 19.

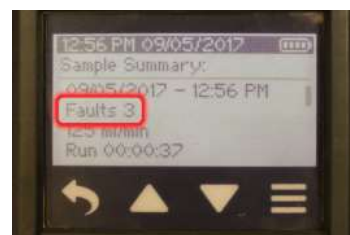
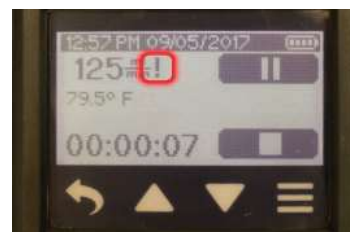
- When the Preset sampling period is complete, the pump will automatically stop sampling, which displays a Sample Summary and automatically resets the accumulated data.

Note: If pump is shut off or goes to sleep after a sample is completed and is powered on again, the initial display will be the Sample Summary of the previous sample run.

Flow Fault Mode and Display

During a sample run, overloaded sample media or kinked tubing can restrict airflow and cause back pressure to build to a point at which the pump can no longer compensate flow within $\pm 5\%$. If this condition is sustained for 3 to 10 seconds, the pump will go into flow fault mode as follows:

- Pump stops running and status LEDs on pump flash red. Elapsed time stops.
- An exclamation point icon appears on the display next to the flow rate.
- After 20 seconds in fault, the pump will attempt to restart up to 5 times.
 - If full airflow is restored during the restart attempts, the pump will continue the sample run.
 - If full airflow is **not** restored during 5 restart attempts within 5 minutes, the pump will end the sample run and display the Sample Summary. The Sample Summary will indicate the number of faults. The LEDs will flash red with decreasing frequency.
- To clear a flow fault, touch any button on the display. **Note:** A flow fault will also be cleared when the battery charge is depleted.

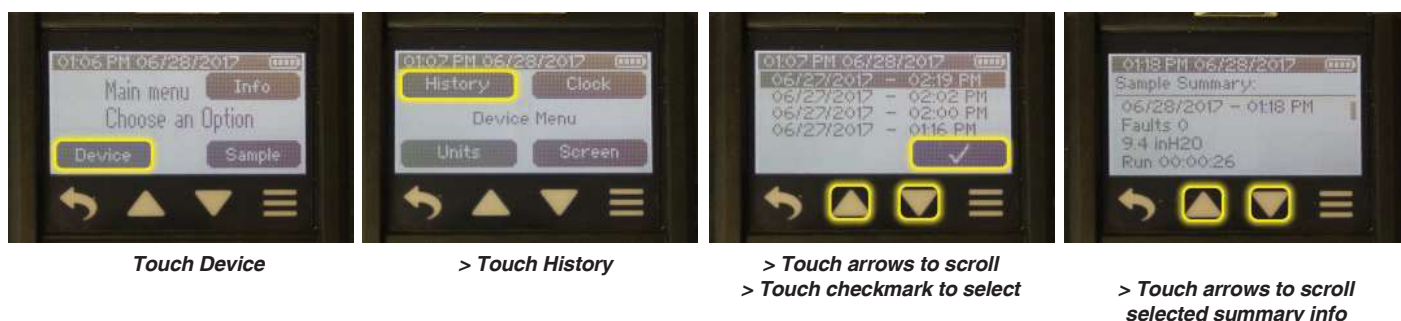


Viewing History

History Menu

To review specific sample run summaries directly on the pump screen

From Main Menu:



Note: The last 16 sample runs can be viewed as Sample Summaries on the pump. A maximum of 4,416 data entries can be held in pump memory. This is equal to approximately 70 hours of one-minute averages or 360 hours of 5-minute averages. To access this data, upload it to DataTrac Pro for Pocket Pump TOUCH Software on your PC.

Using Pocket Pump TOUCH with DataTrac Pro for Pocket Pump TOUCH Software

Pocket Pump TOUCH communicates with a laptop/PC via a USB Bluetooth Adapter (Cat. No. 877-94) and DataTrac® Pro for Pocket Pump TOUCH Software, which is available as a download (requires Internet connection). Access DataTrac Pro for Pocket Pump TOUCH Software using the following procedure:

1. Check that PC meets DataTrac Pro system requirements.

Operating system	Microsoft® Windows® 7, 8, 8.1, or 10
Required software	DataTrac Installer (included with installation)
Minimum display resolution	1024 x 768
Available port	USB 2.0

2. Install the USB Bluetooth Adapter or “dongle” (Cat. No. 877-94) on laptop/PC according to instructions included with adapter.
3. Browse URL provided in adapter instructions, and download and install the DataTrac Pro Installer on laptop/PC. (A flash drive option is available for users without an Internet connection.)
4. Upon successful installation, DataTrac Pro will launch automatically and attempt to find any active Pocket Pump TOUCH pumps within the area.

For further instructions, see the *DataTrac Pro for Pocket Pump TOUCH User Manual*.

Maintenance

Change the Battery Pack Review Notes and Cautions on page 4 before proceeding.

1. **Turn off the pump** by pressing the Power On/Off button located on the top of the non-running pump (*Figure 1*); the screen will go dark.
2. Use a 1.5-mm hex key (provided with pump) to loosen two safety screws on the back of the battery pack housing (*Figure 1*).
3. Orient the pump so that the belt clip faces upward and the pump inlet points left. Using your fingers, grip the battery pack housing just above its top screw and just below its bottom screw and lift up against the belt clip. Once the housing clears the pump case, pull it to the right, away from the pump case.
4. If replacing the battery pack with a new battery pack (Cat. No. P76303), dispose of the used battery promptly and according to all state and local regulations.



Do not disassemble the battery pack. Do not dispose of in fire. Dispose of used batteries promptly according to all state and local recycling or waste regulations.

5. Install a new battery pack or re-install an existing battery pack.
 - a. Align battery pack housing with pump case.
 - b. Use the back of the battery pack housing to push up the belt clip until the battery pack is aligned with the pump case and presses easily into place. Ensure the battery pack housing fits flush with the pump case.
 - c. Use a 1.5-mm hex key to tighten two screws on back of the battery pack housing. Tighten screws in an alternating fashion.
 - d. Charge the battery pack completely before use. *See Charging the Battery Pack on page 3.*

Note: When the battery is reattached to the pump, the screen will light and then go black as the pump performs a firmware check. This lasts approximately 20 seconds and the Main Menu will display as soon as the check is completed.

Clean the Touch Screen

Use a soft, clean, and dust-free cloth to remove fingerprints from the touch screen.  **Do not use alcohol to clean the screen.**

Troubleshooting

Troubleshooting Guide

Issue	Possible Solutions
The display on the pump is frozen.	<ol style="list-style-type: none">1. Press the Power On/Off button to shut off the pump.2. Remove the battery (<i>see Maintenance above</i>)3. Reinstall the battery.



User may replace external components such as the inlet filter, battery, screen protector, and/or belt clip. Service must be performed by SKC to maintain performance and intrinsic safety rating. Warranty is void if pumping compartment is opened by user.

Accessories/Replacement Part Ordering

Accessories	Cat. No.
Single Charger , USB, magnetic connector, supplied as cable and wall cube with U.S. plug	100-240 V 220-300
5-port USB Hub with power cable (U.S. plug), <i>requires up to 5 single charging cables available as Cat. No. P75739</i>	220-400 100-240 V
Quick-connect Bag Sampling Adapter , installs on pump exhaust port for secure connection to tubing for bag sampling, accepts 1/4-inch OD PTFE tubing	220-200
Single Kit Case , nylon, with shoulder strap	224-903
5-pack Kit Case , Pelican	224-915
DataTrac Pro for Pocket Pump TOUCH USB Bluetooth Adapter , <i>required for free software download and use of DataTrac Pro software</i>	877-94
Low Flow Tube Holder with cover (non-adjustable) with A size cover, 6-mm OD x 70-mm L with B size cover, 8-mm OD x 110-mm L with C size cover, 10-mm OD x 150-mm L with D size cover, 10-mm OD x 220-mm L	222-3-1 222-3L-1 222-3XL-1 222-3XD-1
Constant Pressure Controller for multiple-tube sampling in constant flow	224-26CPC-10
Adjustable Multiple-tube Low Flow Holders Dual (holds up to 2 tubes) Tri (holds up to 3 tubes) Quad (holds up to 4 tubes)	224-26-02 224-26-03 224-26-04
Tube Covers A (6-mm OD x 70-mm L) B (8-mm OD x 110-mm L) C (10-mm OD x 150-mm L) D (10-mm OD x 220-mm L)	224-29A 224-29B 224-29C 224-29D
Replacement Battery Pack , ‡ Li-Ion	P76303
Single Charging Cable , USB, without wall cube	P75739
Low Flow chek-mate Calibrator , 20 to 500 ml/min, includes a 9-volt alkaline battery and NIST-traceable calibration certificate	375-00205N

‡ Replacing batteries with non-approved or repaired/rebuilt battery packs voids any warranty and UL Listing for intrinsic safety.

* Li-Ion batteries are subject to special shipping regulations

* Li-Ion Battery Testing and Shipment

Rechargeable lithium-ion batteries for use with SKC sample pumps have been tested in accordance with the UN Manual and are proven to meet requirements of each test in the *UN Manual of Tests and Criteria*, Part III, subsection 38.3. The batteries are rated below 100 watt-hours (Wh).


Consult with your carrier for more information on Lithium Battery Shipping Regulations UN 3480 and UN 3481 or visit SKC's website for more information at www.skcinc.com/catalog/pdf/instructions/1921.pdf

SKC Limited Warranty and Return Policy

SKC products are subject to the SKC Limited Warranty and Return Policy, which provides SKC's sole liability and the buyer's exclusive remedy. To view the complete SKC Limited Warranty and Return Policy, browse <http://www.skcinc.com/warranty>.

Appendix

Appendix: Performance Profile

Flow Range in Constant Flow Mode	20 to 500 ml/min
Compensation Range in Constant Flow Mode	20 to 500 ml/min up to 20 inches water back pressure
Pressure Range in Constant Pressure Mode	1 to 20 inches water
Flow Control System	Corrects for changes in back pressure, temperature, and atmospheric pressure
Power	Removable rechargeable Lithium-ion (Li-Ion) battery, 3.7 V, 2.6 Ah, 9.6 Wh or USB charger
Run Time (Li-Ion)	20+ hrs at 500 ml/min up to 20 inches water back pressure†, extended run times available with charger
Charging Time <i>(varies with battery capacity and level of discharge)</i>	≤ 10 hrs (≤ 4.5 hrs to 80%)
Accuracy	Constant flow control: ± 5% of set-point or ± 3 ml/min, whichever is higher Atmospheric pressure: ± 0.3 in Hg Temperature: ± 1.0 C Real-time clock: ± 1% Constant pressure mode: ± 0.5 inch water
Temperature Ranges	Operating: 32 to 113 F (0 to 45 C) Charging: 32 to 113 F (0 to 45 C) Storage: -4 to 113 (-20 to 45 C)
Humidity Range	≤ 95% RH, non-condensing
Altitude	Corrects flow for changes in temperature (32 to 113 F [0 to 45 C]) and ambient pressure up to 15,000 feet (4572 meters) above and down to 2300 feet (701 meters) below sea level
Flow Fault	After 3 to 10 seconds of restricted flow, pump stops running, elapsed time stops, status LEDs flash red, and pump displays fault icon. After 20 seconds in fault, auto-restart is attempted up to 5 times unless full airflow is restored prior to that. If full airflow is not corrected after 5 auto-restarts within 5 minutes, the pump ends the run and displays Sample Summary.
Display Type/Parameters	High-contrast backlit LCD/Time, date, battery status, flow rate, sample volume, temperature, atmospheric pressure, back pressure, programmed run remaining time, and elapsed run time
User Interface	Eight-area capacitive touch screen with auto-dim and locking options
Dimensions	3.2 x 3.8 x 1.5 in (8.1 x 9.7 x 3.8 cm)
Weight	8.3 oz (235 gm)
Certifications/Markings	<ul style="list-style-type: none"> Intrinsic safety (SKC Cat. No. 220-1000TC operated with SKC Battery Pack Cat. No. P76303) Class I, Groups A, B, C, D; Class II, Groups E, F, G; Class III, T4; Class I, Zone 0, Group IIC T4; Exia -20°C ≤ Ta ≤ 45°C EX II 1G Exia IIC T4 Ga IECEX UL 16.0113 DEMKO 16ATEX 1600 CE 0539 RoHS compliant 
Case Material	IP 64-rated case, polycarbonate with rubberized anti-static overmolding
Communications with PC	Low-energy Bluetooth, requires DataTrac Pro for Pocket Pump TOUCH USB Bluetooth Adapter Cat. No. 877-94
Tubing	Requires 1/4-in ID tubing

† Tested using 37-mm 0.8 µm MCE filter with new pump and battery. Pump performance may vary.