



[www.skcltd.com](http://www.skcltd.com)

# Flite4 High Volume Air Sampling Pump

## Operating Instructions



---

**This manual covers the following models:**

**901-4011 / 901-4012**

## Purchase Details and Service History

Thank you for choosing an SKC product. Your purchase is covered by our warranty, details of which can be found inside the rear cover of this manual.

Product Model Number	Product Serial Number	Date of Purchase

SKC recommends annual servicing of this product. The first service is due one year from the date of purchase, and then at yearly intervals on this date. However, it is the responsibility of the user to perform a risk assessment to determine the necessary frequency of servicing that is required.

Service	Date	Service	Date	Service	Date
1		5		9	
2		6		10	
3		7		11	
4		8		12	

Please note that SKC Ltd are the only authorised service centre in the UK, guaranteeing you access to the full range of genuine SKC replacement parts. For all other areas a full list of SKC approved distributors and service centres can be found at [www.skcltd.com](http://www.skcltd.com)

SKC UK service centre - Tel: +44 (0)1258 480188 Email: [info@skcltd.com](mailto:info@skcltd.com)

Specifications.....	2
General Information -	
1) Pump Model.....	5
2) Care of the Flite4 Pump.....	5
3) Waste Electrical and Electronic Equipment.....	5
4) Waste Batteries .....	5
The Flite4 Pump.....	6
Getting Started -	
1) Fitting the Battery.....	7
2) Charging the Battery .....	8
3) Battery Status Display .....	8
4) Use of the Keypad and LCD Screen.....	10
5) Sleep Mode .....	11
Programming the Flite4 Pump -	
1) Setting the Flow Rate .....	13
2) Setting Manual Operation.....	14
3) Setting a Timed Run .....	15
4) Clear a Sampling Program.....	18
5) Reviewing a Sampling Program .....	19
Operating the Flite4 Pump -	
1) Manual Run.....	21
2) Single Timed Run.....	23
3) Single Timed Run with Delayed Start.....	24
4) Timed Run with Repeat Runs .....	26
Troubleshooting .....	28
Battery Care .....	29
Flite4 Pump Components .....	30
Flite4 Pump Head and Motor Components .....	31
Flite4 Pump Replacement Parts .....	32
Flite4 Pump Accessories .....	33
Warranty Information.....	34

# Specifications

Parameter	Model 901-4011	Model 901-4012
Weight (without battery)	2.06 kg	2.09 kg
Weight (with P901402 battery)	4.26 kg	4.29 kg
Dimensions	163mm W x 112mm H x 203mm D	
Casing IP rating	IP20	
Flow range	2 to 20 litre/min	
Battery	12V sealed lead/acid	
Storage temperature	-5 to +50 °C	
Operating temperature	-5 to +50 °C	
Charging temperature	-5 to +45 °C	
Relative humidity	0 to 95 % RH	
Noise level	63 dB(A) at 1 metre*	

\* Representative noise level at flow rate of 8 litre/min and back pressure of 100 inches of water (24.9 kPa).

Back Pressure Range		
Flow rate (litre/min)	Maximum back pressure	
	(inches of water)	(kPa)
2	205	51.0
4	175	43.5
8	125	31.1
12	85	21.1
16	50	12.4
20	15	3.7

**Note:**

SKC Ltd reserves the right to make changes to the specification and design of this product at any time without prior notice to the end user.

<b>Pump Features</b>	
Intelligent battery charging	<p>The SKC lead/acid battery charger (Part No. 901-410) provides optimum charging in the minimum possible time. The charger automatically detects when the battery is fully charged and switches to a trickle charging rate to prevent over-charging. Typical charging time for a fully discharged battery is 10 hours for the P901402 7Ah battery.</p> <p><b>Note:</b> The battery charger can only be used to charge the battery when the pump is <b>not</b> running; it cannot be used when the pump is running to extend the pump runtime. To achieve extended runtimes refer to “External power supply options” below.</p>
External power supply options	<p>The pump can be powered by a mains adapter (Part No. 901-411) suitable for 100-240V ~ 50/60Hz mains supplies, or by an external high capacity 12V lead/acid battery (such as Part No. P901107 - 12Ah) using an external battery hookup cable (Part No. 901-212).</p> <p><b>Note:</b> It is recommended to use these options in conjunction with a P901402 internal battery in order to retain the pump program and runtime data when external power supplies are disconnected.</p>
Battery status display	Indication of battery charge status - 100%, 75%, 50%, 25% and flat battery status.
Flat battery	Automatic flat battery shutdown with indication on LCD screen, plus elapsed runtime retention, in the event of a flat battery condition.
Timer display	LCD screen indicates sample runtime in hours, minutes and seconds.
Programmable runtime	Sample runtime programmable in hours and minutes, via keypad and LCD screen.
Programmable delayed start time	Sample start delay time programmable in hours and minutes, via keypad and LCD screen. Start delay countdown display on LCD screen in operation.
Programmable repeat runs	Number of sample period repeats and interval between repeats programmable via keypad and LCD screen. Indication of sample period repeats on LCD screen in operation.

Typical Pump Runtimes		
Filter Type	Flow Rate	Runtime P901402 7Ah Battery
25mm 0.8µm MCE	4 litre/min	30 hours
	8 litre/min	14 hours
	12 litre/min	6 hours
25mm 1.2µm MCE	4 litre/min	35 hours
	8 litre/min	16 hours
	12 litre/min	8 hours
25mm GFA	8 litre/min	22 hours
	12 litre/min	13 hours
	16 litre/min	7 hours

The pump runtime tests were carried out with new fully charged batteries under clean factory conditions, therefore the results do not take account of filter loading. Pump performance and filter back pressure may vary.

**Note:** These are **not** suggested flow rates for sampling methods - they are pump performance indicators.

## 1) Pump Models

901-4011	High flow sample pump 2 - 20 litre/min (without battery)
901-4012	Twin port high flow sample pump 2 - 20 litre/min (without battery)

## 2) Care of the Flite4 Pump

- The Flite4 pump is supplied complete with a rubber dust cap for the inlet hoesetail and a screw-in dust cap for the charging/power socket. Please ensure that these are fitted at all times when the pump is not in use or being charged.
- Never run the Flite4 pump without a filter in line to prevent dust from contaminating the pump mechanism.
- Always use the correct SKC battery and battery charger designated for the Flite4 pump.
- The Flite4 pump casing is IP20 rated, it is not rated as water or splashproof and therefore must not be used where it is possible for water to enter the pump casing, and care must be taken when cleaning the pump to prevent water ingress.

**Warning - Failure to follow these guidelines will void the product warranty.**

## 3) Waste Electrical and Electronic Equipment



This product is marked with the crossed out wheellie bin symbol, which identifies that it falls within the scope of the EU Directive 2002/96/EC and the 2013 UK Regulations on waste electrical and electronic equipment (WEEE). At the end of its useful life, this product must be disposed of in an environmentally sound way as detailed in the Directive / Regulations. Note that the battery must be separated from the pump and disposed of as detailed in Waste Batteries below. Please contact your local distributor or SKC Ltd for further details on how to comply with these requirements. SKC Ltd's producer registration number is WEE/KH0054TQ.

## 4) Waste Batteries

The lead/acid batteries supplied for use with this pump, fall within the scope of the EU Directive 2006/66/EC and the 2009 UK Regulations on batteries and accumulators and waste batteries and accumulators. At the end of a battery's life it must be disposed of in an environmentally sound way as detailed in the Directive / Regulations. Please contact your local distributor or SKC Ltd for further details on how to comply with these requirements. SKC Ltd's batteries producer registration number is BPRN00454.

# The Flite4 Pump





## 1) Fitting the Battery

The Flite4 pump is supplied without a battery fitted.

To fit the P901402 battery, unfasten the 6 casing screws (3 each side of the case) using the supplied Pozidriv size PZ1 screwdriver. Lift off the blue casing cover.

Remove the two protective covers from the battery terminals and place the battery into the rear compartment of the pump case as shown. Ensure equal gaps are left between the ends of the battery and sides of the case to allow for the case screws to be screwed in fully without damaging the battery.

Connect the red battery cable from the pump control PCB to the red '+' terminal on the battery, and the black battery cable to the black '-' terminal on the battery.

Refit the blue casing cover, securing with the 6 screws using the Pozidriv size PZ1 screwdriver.



## 2) Charging the Battery

Prior to first use the battery should be fully charged, ideally overnight.

The Flite4 pump must only be charged using the correct SKC charger (Part No. 901-410).

The charger is supplied with mains input plugs suitable for use in the UK, Europe, USA and Australia/New Zealand. Select the correct mains input plug and fit to the charger.

Unscrew the dust cap from the charging/power socket on the pump and connect the output connector from the charger to the pump socket. Screw the charging connector into the socket to prevent it from detaching whilst charging.

Plug the charger into the electrical mains supply and switch on the power. The LED indicator on the charger will illuminate amber to indicate that the charger is charging at full rate.

Leave the pump to charge fully. A fully depleted battery will take approximately 10 hours to charge. When the battery is fully charged the LED indicator on the charger will illuminate green to indicate that the charger has switched to trickle charge.

When fully charged, switch off the mains power to the charger and disconnect the charger output connector from the pump. Always fit the screw-in dust cap to the charging/power socket on the pump after charging.

**Note:** The battery charger can only be used to charge the battery when the pump is **not** running; it cannot be used when the pump is running to extend the pump runtime.

## 3) Battery Status Display

The pump can display the battery status - refer to 5) Reviewing a Sampling Program on Page 19 for details of how to access the battery status screen.

**Key to battery status:**

Battery Status  
>>> Good - Battery at 75% to 100% capacity.

Battery Status  
>>\_ Good - Battery at 50% to 75% capacity.

Battery Status  
>>\_ Medium - Battery at 25% to 50% capacity.

Battery Status  
>\_\_ Low - Battery below 25% capacity.

Battery Status  
\_\_\_ Exhausted - Battery fully exhausted.

**Flat battery indication:**

Flat Battery  
CONNECT CHARGER - If the battery is fully exhausted the pump will show the flat battery screen:

- When waking the pump from 'Sleep'.
- When attempting to run the pump. The pump will not run when the battery is fully depleted.
- When the pump is running. The pump will automatically stop and retain the elapsed runtime in memory.

The battery must be charged to at least 75% capacity to clear the flat battery screen.

## 4) Use of the Keypad and LCD Screen

Key functions -

 - Switches between menu options and selects digits to adjust when entering times.

 - Enters the selected menu option or runtime.

 and  - Used to enter the sample runtimes and set the pump flow rate.

The available options for each menu item are displayed on the bottom line of the LCD screen. The currently selected option is indicated with a flashing cursor.



```
SELECT Sleep
Run Setup Review
```

Press the  key to cycle through the available options as shown.

 → 

```
SELECT Sleep
Run Setup Review
```

 → 

```
SELECT Sleep
Run Setup Review
```

Press the  key to accept the selected menu option. The next menu screen will be shown on the LCD screen as shown.

 → 

```
Battery Status
>>>> Good
```

On number entry menu screens, such as the sample runtime screen, each digit of the hours and minutes is entered individually. The currently selected digit is identified by the flashing cursor.

Press the  key to cycle through the digits as shown.

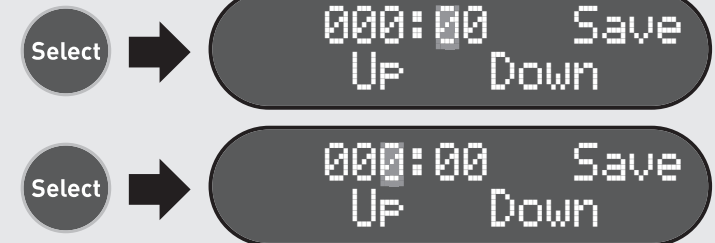

Use the  and  keys to enter the required value for the selected digit as shown.



Use the  key to cycle to the 'Save' option on the screen.



Press the  key to save the runtime. The display will revert to the previous menu screen as shown.



## 5) Sleep Mode

When not in use the pump should be put into sleep mode to conserve battery power. The LCD display appears as shown when in sleep mode. The display backlight will dim after 5 minutes to conserve battery power.



To wake the pump from sleep mode press the keypad keys in the sequence - , , . The pump will display the 'SELECT' main menu screen.

To put the pump back into sleep mode, on the 'SELECT' main menu screen cycle to the 'Sleep' option, and press

.



## 1) Setting the Flow Rate

Fit a new filter into the sampling head and connect the sampling head outlet to the pump inlet hosetail using a length of flexible tubing. Connect the sampling head inlet to the outlet of a flow calibration device, such as a chek-mate electronic flowmeter or rotameter.

Cycle to the 'Setup' option in the 'SELECT' main menu screen, and press  to display the 'Setup' menu screen.



On the 'Setup' menu screen cycle to the 'Flow' option and press . The pump will start to run and the 'SET FLOW' screen will be displayed.

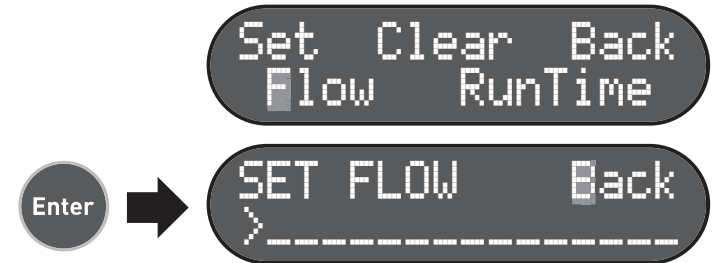

Press  to increase the pump flow rate. More arrow symbols are displayed on the LCD screen to indicate the increased flow rate.

**Note:** Pressing and holding  will rapidly increase the pump flow rate.

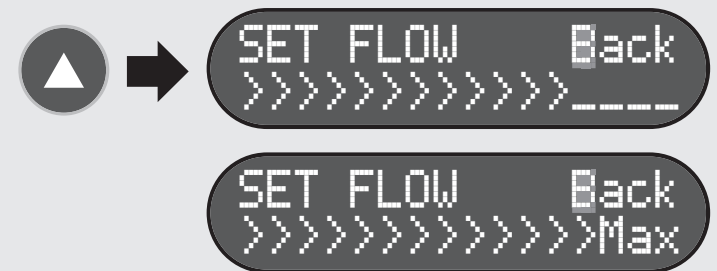

When the maximum possible pump flow rate is reached, this is indicated on the LCD screen as shown.



Press  to decrease the pump flow rate. Fewer arrow symbols are displayed on the LCD screen to indicate the reduced flow rate.

**Note:** Pressing and holding  will rapidly decrease the pump flow rate.

When the minimum possible pump flow rate is reached, this is indicated on the LCD screen as shown.

Observing the reading of the flow calibrator, use the  and  keys to set the required flow rate. When the pump is running at the required flow rate press  to save the flow rate setting and return to the 'SELECT' main menu screen.

Having set the required pump flow rate, disconnect the flow calibrator from the sampling head inlet. Remove the filter from the sampling head and replace it with a fresh new filter. Fit the sealing cap to the sampling head inlet to prevent contamination of the filter prior to sampling.

## 2) Setting Manual Operation

To run the pump manually, ensure that no timed run, delayed start or repeat runs are programmed.

Use the 'Clear' function (detailed on Page 18) to clear all sample program data and the last elapsed runtime from the pump memory.

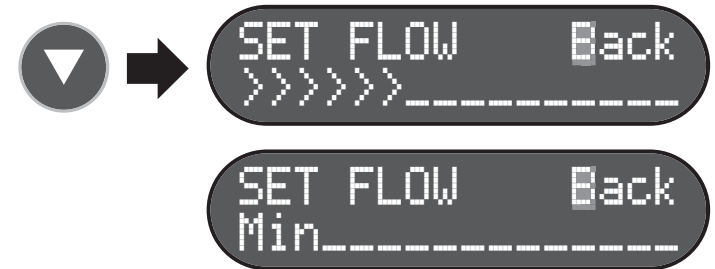



### 3) Setting a Timed Run

Having set the pump flow rate to the desired level, from the 'SELECT' main menu screen cycle to the 'Setup' option, and press **Enter** to display the 'Setup' menu screen.



On the 'Setup' menu screen cycle to the 'Runtime' option, and press **Enter** to display the 'Runtime' menu screen.

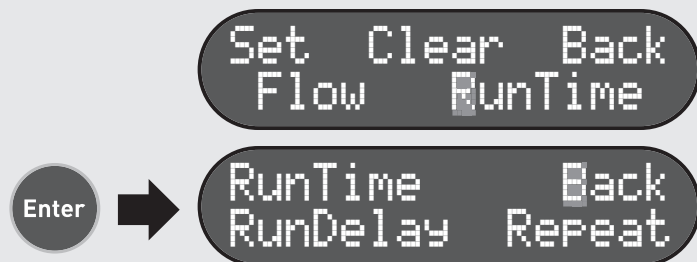

On the 'RunTime' menu screen cycle to the 'RunTime' option, and press **Enter**.



Use the **Select**, **▲** and **▼** keys to enter the required sample runtime in hours and minutes.



Cycle to the 'Save' option and press  to save the sample runtime and return to the 'RunTime' menu screen.



To enter a start delay time, on the 'RunTime' menu screen cycle to the 'RunDelay' option, and press .



Use the ,  and  keys to enter the required start delay time in hours and minutes.



Cycle to the 'Save' option and press  to save the start delay time and return to the 'RunTime' menu screen.



To program repeat sample run and delay times, on the 'RunTime' menu screen cycle to the 'Repeat' option, and press **Enter** to display the 'Set Repeat' menu screen.



To enter the time delay between repeats, on the 'Set Repeat' menu screen cycle to the 'Delay' option and press **Enter**.





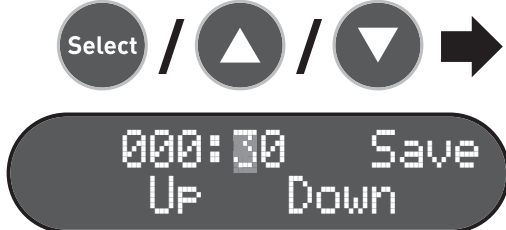

Use the **Select**, **▲** and **▼** keys to enter the required repeat delay time in hours and minutes.



Cycle to the 'Save' option and press **Enter** to save the repeat delay time and return to the 'Set Repeat' menu screen.



To enter the number of repeats, on the 'Set Repeat' menu screen cycle to the 'Number' option and press .

Use the ,  and  keys to enter the required number of repeats.

**Note:** A setting of '00' repeats disables the sample repeat function. A setting of '01' gives the same result as programming a single timed run.

Cycle to the 'Back' option and press  to save the number of repeats and return to the 'Set Repeat' menu screen.

## 4) Clear a Sampling Program

To clear a sampling program and the previous sample elapsed runtime from the pump's memory, on the 'Setup' menu screen cycle to the 'Clear' option and press .

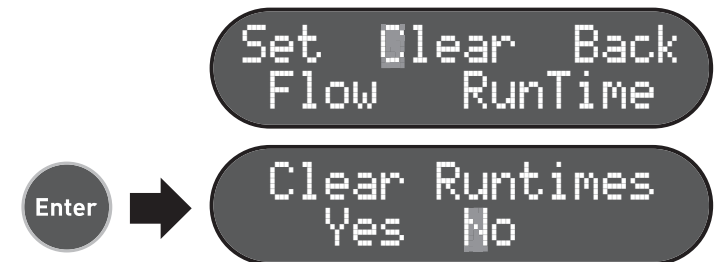

Cycle to the 'Yes' option and press  to clear the sample program and return to the 'Setup' menu screen.

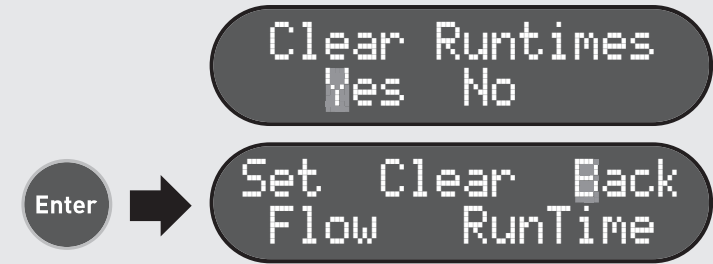

## 5) Reviewing a Sampling Program

When a sampling program has been entered the settings can be quickly viewed by cycling to the 'Review' menu option on the 'SELECT' main menu screen and pressing  to display the first review screen, which is the 'Battery Status' screen.



Press  to display the next review screen, which is the 'Time To Start' screen. This screen is only displayed if a start delay time has been programmed.

The screen indicates the start delay time set in hours, minutes and seconds.

If a number of repeats has been programmed this will also be displayed on this screen.

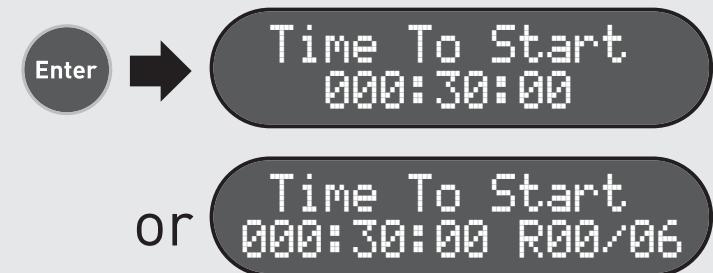

# Programming the Flite4 Pump

Press  to display the next review screen, which is the 'Previous Run' screen.

This will be the 'Previous Run' time - the elapsed runtime the previous pump sample run. If there is no previous time recorded in the pump memory this will display '000:00:00'.



Press  to display the next review screen, which is the 'Timed Run Set' Screen. This screen is only displayed if a sample run time has been programmed.

The screen indicates the length of the sample run time set in hours and minutes.



Press  to display the next review screen, which is the 'Repeats Set' screen. This screen is only displayed if a number of sample repeats have been programmed.

The screen indicates the number of repeats and the delay time between each repeat run in hours and minutes.



Press  to return to the 'SELECT' main menu screen.



## 1) Manual Run

Having programmed the desired flow rate and fitted a new filter into the sampling head, place the pump at the sampling location and ensure that the sealing cap is removed from the sampling head inlet.

If the pump is in sleep mode, wake it to display the 'SELECT' main menu screen. Cycle to the 'Run' option and press .

The pump will run and the elapsed runtime will be displayed counting up in hours, minutes and seconds.

A number of options are available during a sample run.

To access these options, simultaneously press the  and  keys to display the 'SELECT Hold' screen.

**Note:** The pump is still running at this point, but whilst the 'Hold' screen is displayed the elapsed runtime is NOT incrementing.

On the 'SELECT Hold' screen cycle to the 'Continue' option and press  to continue running and return to the elapsed runtime screen.

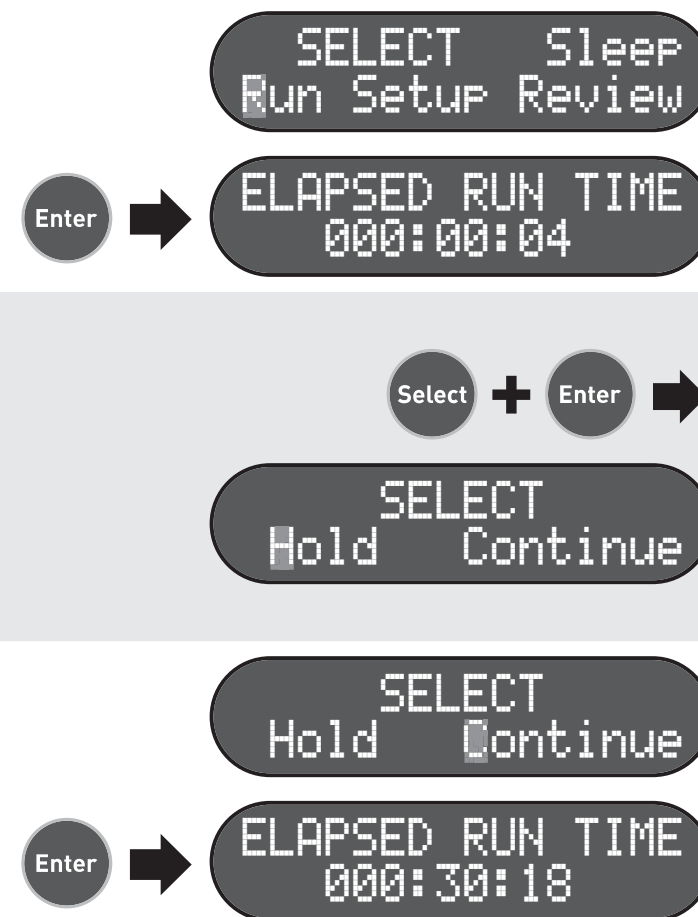

# Operating the Flite4 Pump

On the 'SELECT Hold' screen cycle to the 'Hold' option and press  to stop the pump running and display the Hold menu screen, which also shows the current elapsed runtime.



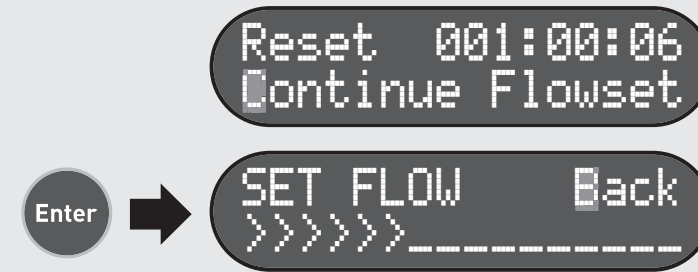

To check and adjust the pump flow rate, on the Hold menu screen cycle to the 'Flowset' option and press . The pump will run and display the 'SET FLOW' screen.

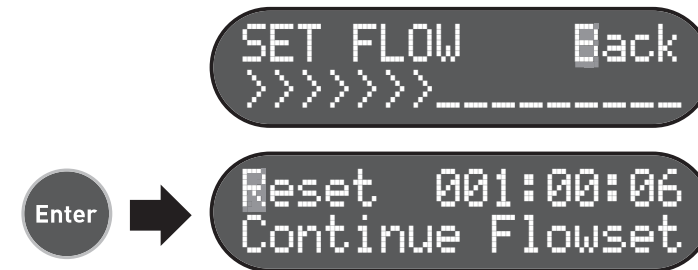

**Note:** The elapsed runtime does not increment whilst checking and adjusting the flow rate.

Adjust the pump flow rate using a suitable flow calibrator and press  to save the new flow rate. The pump will stop running and return to the Hold menu screen.



To continue the sample run, on the Hold menu screen cycle to the 'Continue' option and press . The pump will resume running and the elapsed runtime screen will be displayed and continue to increment.







To complete the manual sample run at the end of the required sample time, on the Hold menu screen cycle to the 'Reset' option and press . The display will return to the 'SELECT' main menu screen.



## 2) Single Timed Run

Having previously programmed a single timed run without delayed start and repeat runs, on the 'SELECT' main menu screen cycle to the 'Run' option and press  to start the pump. The elapsed runtime will be displayed counting up in hours, minutes and seconds.



During a single timed run the same options as detailed for a manual run are available by simultaneously pressing the  and  keys to display the 'SELECT Hold' screen.

**Note:** The pump is still running at this point but whilst the 'Hold' screen is displayed the elapsed runtime is NOT incrementing.

At the end of the timed run the pump will automatically stop and retain the elapsed runtime on the LCD screen.

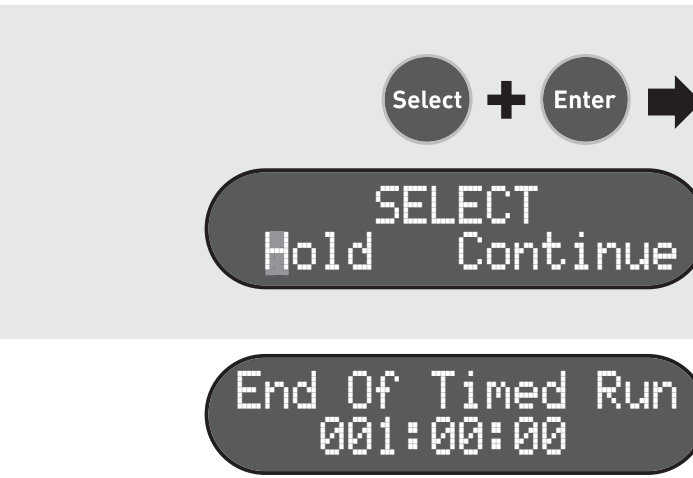

Press the **Select** and **Enter** keys simultaneously to return to the 'SELECT' main menu screen.



### 3) Single Timed Run with Delayed Start

Having previously programmed a single timed run with delayed start, on the 'SELECT' main menu screen cycle to the 'Run' option and press **Enter** to start the sample program. The 'Time To Start' screen is displayed, and indicates the start delay time countdown in hours, minutes and seconds.



During the start delay countdown the sample program can be cancelled by simultaneously pressing the **Select** and **Enter** keys to show the reset screen.



On the reset screen cycle to the 'Reset' option and press **Enter** to cancel the sample program and return to the 'SELECT' main menu screen.





Alternatively, on the reset screen cycle to the 'Continue' option and press  to return to the start delay countdown.



When the start delay countdown reaches 000:00:00 the pump will automatically start and the elapsed runtime is displayed.



During the single timed run the same options as detailed for a manual run are available by simultaneously pressing the  and  keys to display the 'SELECT Hold' screen.





**Note:** The pump is still running at this point but whilst the 'Hold' screen is displayed the elapsed runtime is NOT incrementing.



At the end of the single timed run the pump will automatically stop and retain the elapsed runtime on the LCD screen.



Press the  and  keys simultaneously to return to the 'SELECT' main menu screen.



SELECT Sleep  
Run Setup Review

## 4) Timed Run with Repeat Runs



Having previously programmed a timed run with repeat runs, on the 'SELECT' main menu screen cycle to the 'Run' option and press  to start the sample program.

If a delayed start has been programmed then the time to start countdown timer is displayed in hours, minutes and seconds. The repeat counter showing the current repeat 'R01' of the total number of repeats is also displayed.



SELECT Sleep  
Run Setup Review

Time To Start  
000:29:54 R01/06

During the start delay time the same options as detailed for a single timed run with start delay are available by simultaneously pressing the  and  keys to display the 'SELECT Hold' screen.



SELECT  
Hold Continue

If no delayed start has been programmed or at the end of the delayed start time the pump will automatically run and the elapsed time of the first sample repeat period is displayed in hours, minutes and seconds.

Elapsed Run Time  
000:00:03 R01/06

The pump will run for the programmed sample runtime and at the end of this the pump will automatically stop, and the repeat delay countdown time will be displayed. The repeat counter will increment.

The pump will continue to cycle through the remaining repeat delay periods and sample run periods, incrementing the repeat counter after each repeat run.

At the end of the last sample run period, the pump will automatically stop and display the total elapsed sample runtime. This is the combined total of all of the times of the sample run periods, so for example, if the runtime was 1 hour and the number of repeats was 6, then the total elapsed runtime will be 6 hours.





Time To Restart  
000:09:56 R02/06



Elapsed Run Time  
005:59:27 R06/06



End Of Timed Run  
006:00:00



Press the  and  keys simultaneously to return to the 'SELECT' main menu screen.



SELECT Sleep  
Run Setup Review

Should the Flite4 pump detect that the battery is at a low charge state, a flat battery message will be displayed on the LCD screen. Charge the battery fully using the correct SKC charger before use.

Flat Battery  
CONNECT CHARGER

The Flite4 pump control board monitors the pump motor speed whilst running. If the motor speed signal is not detected, for example due to a disconnected wiring connection to the motor or a failure of the motor, the pump will display a motor fault warning message and retain the elapsed runtime in memory. Press the  and  keys simultaneously to clear the message and return to the 'SELECT' main menu screen.

\* Motor Fault \*  
001:17:48



SELECT Sleep  
Run Setup Review

Possible Fault	Corrective Action
Sample media fault	<ol style="list-style-type: none"> <li>1. Check media for heavy loading or damage.</li> <li>2. Rectify problem.</li> <li>3. Try restarting the pump.</li> </ol>
Sample train fault	<ol style="list-style-type: none"> <li>1. Check tubing for blockage or crimping.</li> <li>2. Rectify problem.</li> <li>3. Try restarting the pump.</li> </ol>
Software error (frozen keypad)	<ol style="list-style-type: none"> <li>1. Disconnect battery for one minute, reconnect.</li> <li>2. Try restarting programming.</li> </ol>

For further assistance contact your supplier or SKC customer care - +44 (0) 1258 480188.

The Flite4 pump utilises a sealed, valve regulated, lead/acid battery. This type of battery requires no maintenance and when used in accordance with the manufacturer's instructions should give a life of approximately 400 charge/discharge cycles (based on 50% depth of discharge). Battery life is affected by a number of factors, but the most significant of these are overcharging and the depth of discharge in use.

Overcharging of the battery causes overheating and off-gassing of the battery electrolyte which will lead to loss of capacity and reduced service life. The Flite4 charger (part no. 901-410) is an intelligent charger which automatically detects when the battery is fully charged and switches to a trickle charging rate to prevent overcharging. Always use the correct charger.

A deeper discharge of the battery prior to charging will result in a shorter battery life. This can be as low as 200 charge/discharge cycles if the battery is fully discharged every time prior to charging.

**Long term storage** - If the pump is to remain unused for a long period of time, SKC recommends that the battery be fully charged prior to storage, and a top up charge be carried out at 6 monthly intervals, or if stored at a temperature in excess of 30°C, at 3 monthly intervals. Failure to do so could lead to significant reduction in battery capacity and service life, and in extreme cases can prevent the battery from accepting a charge entirely. Note that the pump should either be put into 'Sleep' mode during long term storage, or ideally the battery wires disconnected from the battery terminals (these would need to be reconnected during top up charging).

**Battery Disposal** - The EU Battery Directive and UK Battery Regulations require that all lead/acid batteries are disposed of correctly at the end of their working life. This means that they must be collected and treated separately from other waste to ensure that the harmful lead they contain does not enter the environment via landfill sites. Please ensure that any end-of-life SKC batteries are collected and treated correctly.

# Flite4 Pump Components

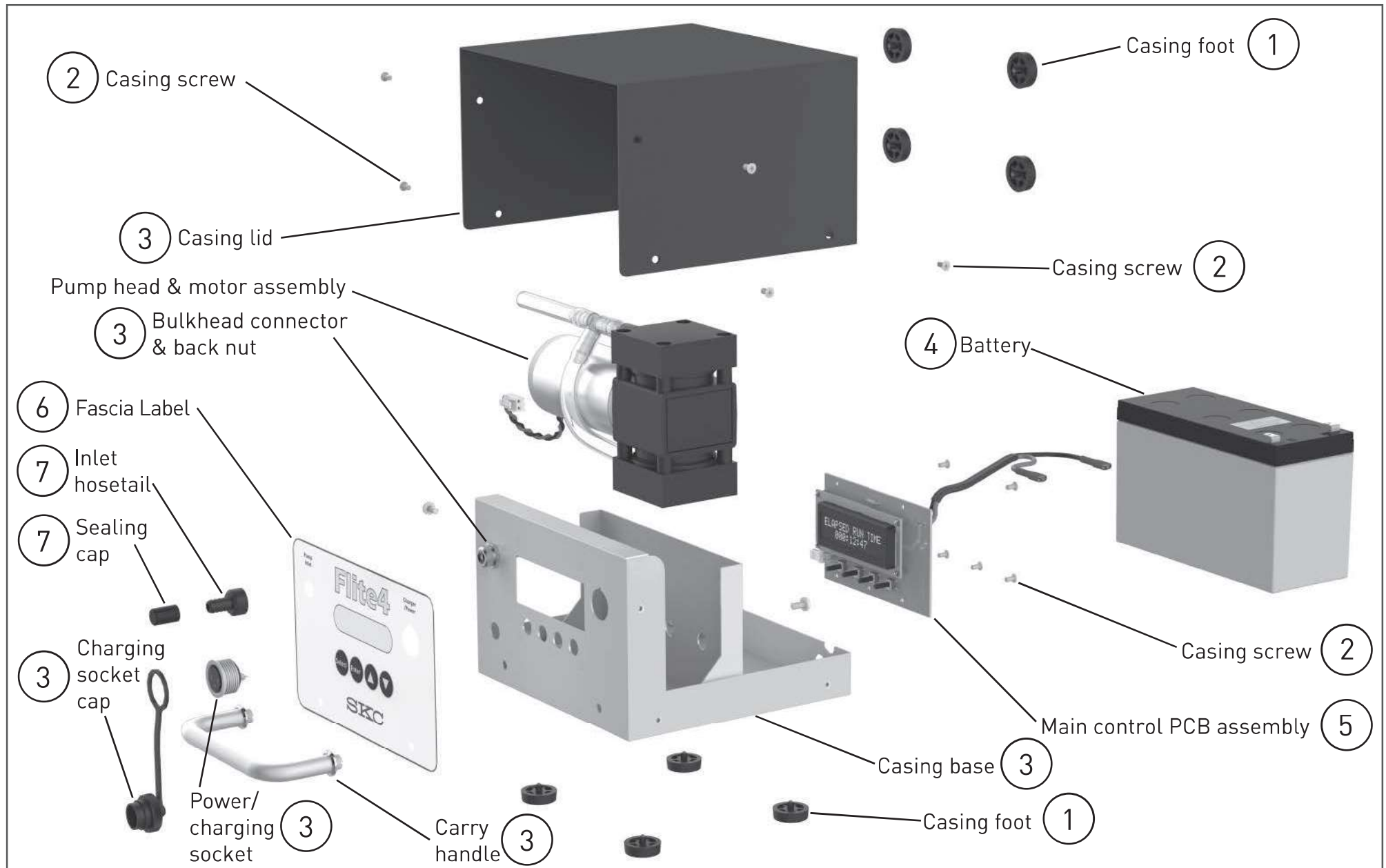



# Flite4 Pump Head and Motor Components

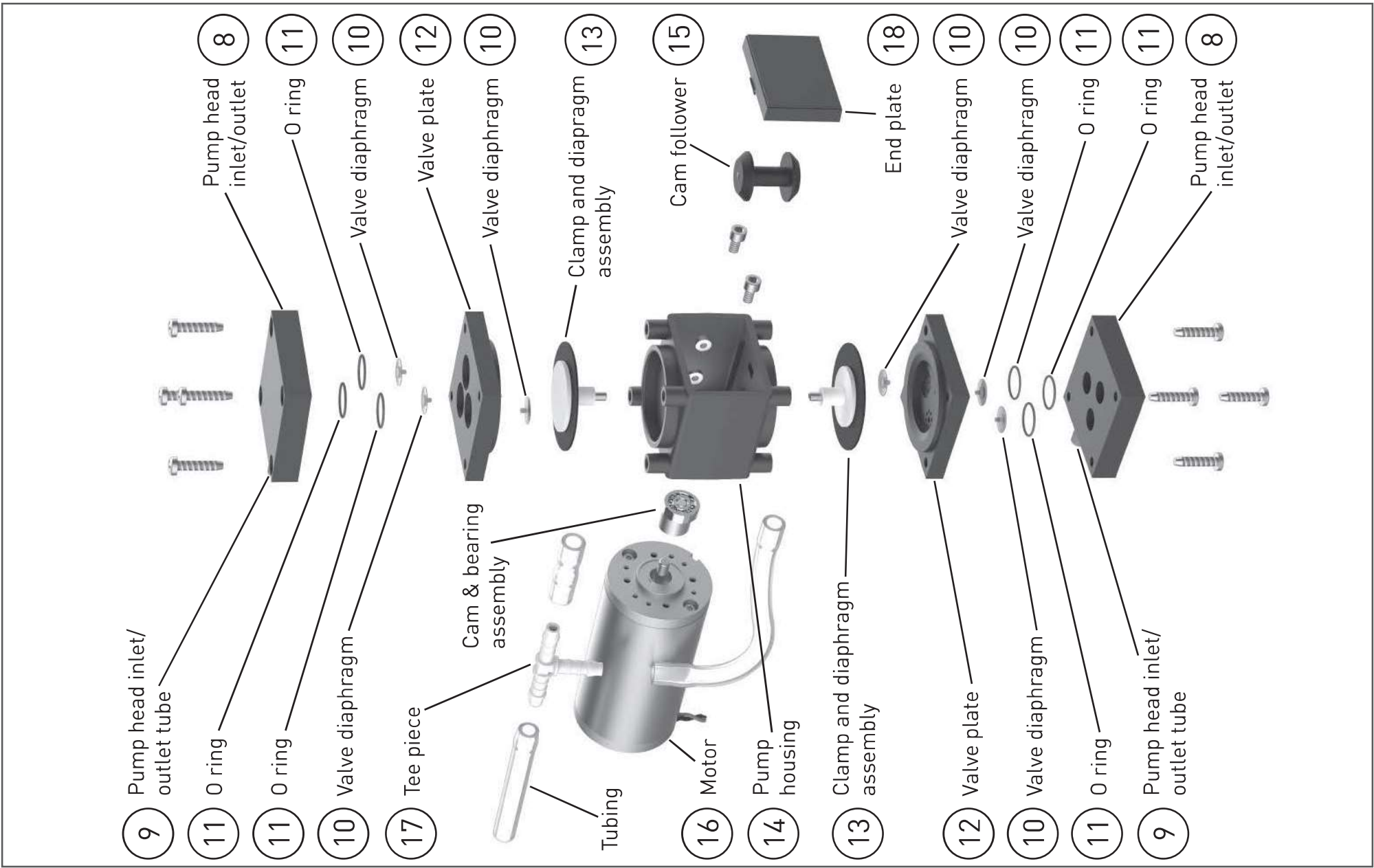

# Flite4 Pump Replacement Parts

Item	Part No.	Description	Item	Part No.	Description
1	P901111	Casing feet (pack of 4)	10	P901407	Valve diaphragm (pack of 6)
2	P901110	Casing screws (pack of 10)	11	P901408	'O' ring (pack of 6)
3	P901404	Casing base	12	P901409	Valve plate
4	P901402	Battery 12V 7Ah lead/acid	13	P901410	Clamp & diaphragm assembly
5	P901403	Main control PCB assembly	14	P901122	Pump housing
6	P901405	Fascia label	15	P901411	Cam follower
7	P901108	Inlet hosetail	16	P901412	Motor
8	P901406	Pump head inlet / outlet	17	P901118	Tubing 'tee' piece
9	P901208	Pump head inlet / outlet tube (pack of 2)	18	P901413	End plate

If the required part is not listed, contact SKC customer care on +44 (0) 1258 480188.

**Note:** Table item numbers correspond to the ringed numbers shown in the figures on Pages 30 and 31 of this manual.

Part No.	Description
901-410	Battery charger 100-240V ~ 50/60Hz - 12Vdc 1A with UK/EU/US/AUS mains plugs
901-411	Mains adapter 100-240V ~ 50/60Hz - 12Vdc 2A with UK/EU/US/AUS mains plugs
P901107	12V 12Ah high capacity lead/acid battery (requires 901-212 cable)
901-212	External battery hookup cable with crocodile clip connectors
901-213	Rigid aluminium sampling mast - two piece 1 metre high
901-214	Rigid aluminium sampling mast - four piece 1 metre high
225-54A	'Asbestos' cowled sampling head aluminium
225-1913	Gridded MCE filters 25mm diameter 0.8 micron pore size (pack of 100)
375-50300	chek-mate flowmeter 5 - 30 litre/min accuracy $\pm 1\%$ of reading
375-150	Pulsation dampener for use with 375-50300 chek-mate flowmeter
393-1130	Rotameter 1.0 - 13.0 litre/min accuracy 2.5% to VDI/VDE 3513-2:2008
393-2260	Rotameter 2.0 - 26.0 litre/min accuracy 2.5% to VDI/VDE 3513-2:2008
391-05	Flow calibration adapter for cowled asbestos heads

If the required item is not listed, contact your supplier or SKC sales on +44 (0) 1258 480188.

SKC provide a wide range of sampling media, including filters, sorbent tubes and impingers. A full selection can be found in the current SKC catalogue and at [www.skcltd.com](http://www.skcltd.com)

## Limited One Year Warranty

1. SKC warrants that this instrument, and each of its component parts, provided for occupational health and safety and environmental applications is free from defects in workmanship and materials under normal use for a period of one (1) year. This warranty DOES NOT cover any claims due to abuse, misuse, neglect, alteration, or accident, or use in application for which the instrument was either not designed or not approved by SKC, or, due to the buyer's failure to maintain normal maintenance, improper selection or misapplication. The warranty also DOES NOT cover any claims due to the use of a non-SKC approved charger to charge the battery pack. This warranty shall further be void if changes or adjustments to the instrument are made by a person other than an employee of the seller or, if the operating instructions furnished at the time of installation are not complied with.

2. SKC hereby expressly disclaims all warranties either expressed or implied, including any implied warranties of merchantability or fitness for a particular purpose and neither assumes nor authorizes any person to assume for it any liability in connection with the sale of these instruments. No description of the goods being sold has been made a part of the basis of the bargain or has created or amounted to an express warranty that the goods will conform to any such description. Buyer shall not be entitled to recover from SKC any consequential damages; damages to property, damages for loss of use, loss of time, loss of profits or income or any other incidental damages. Nor shall the Buyer be entitled to recover from SKC any consequential damages resulting from defect of the instrument.

3. This warranty extends only to the original purchaser of the warranted instrument during the term of the warranty, the buyer may be required to present proof of purchase in the form of a paid receipt for the instrument.

4. In the event of a defect, malfunction, or other failure of the instrument not caused by any misuse or damage to the instrument while in the possession of the Buyer, SKC will remedy the failure or defect

without charge to the buyer. The remedy will consist of service or replacement of the instrument, or refund of the purchase price, at the option of SKC. However, SKC will not elect refund unless it is unable to provide replacement and repair is not commercially practicable.

5. The terms of this warranty begin on the date the instrument is delivered to the Buyer and continue for a period of one (1) year.

6(a) To obtain performance of any obligation under this warranty, the buyer shall return the instrument, freight prepaid to SKC at the following address:-

SKC Limited

11 Sunrise Park

Higher Shaftesbury Road

Blandford Forum

Dorset DT11 8ST

Phone: +44 (0) 1258 480188

Email: [info@skcltd.com](mailto:info@skcltd.com)

6(b) To obtain further information on the warranty performance contact SKC.

7. This warranty is provided under English law.

8. No other warranty is given by SKC in conjunction with this sale.

The disclaimers and limitations shall not affect the statutory rights of a consumer.

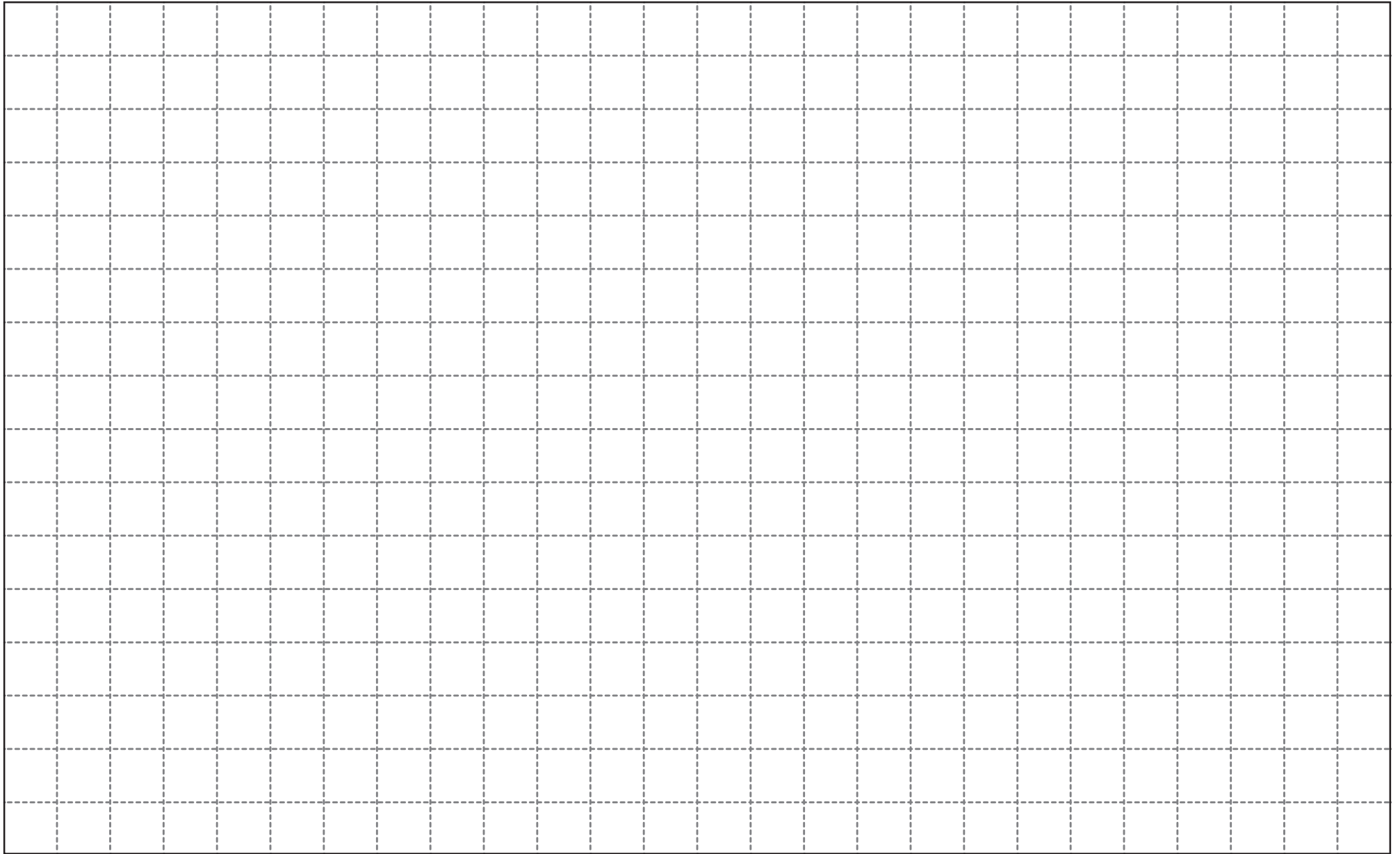

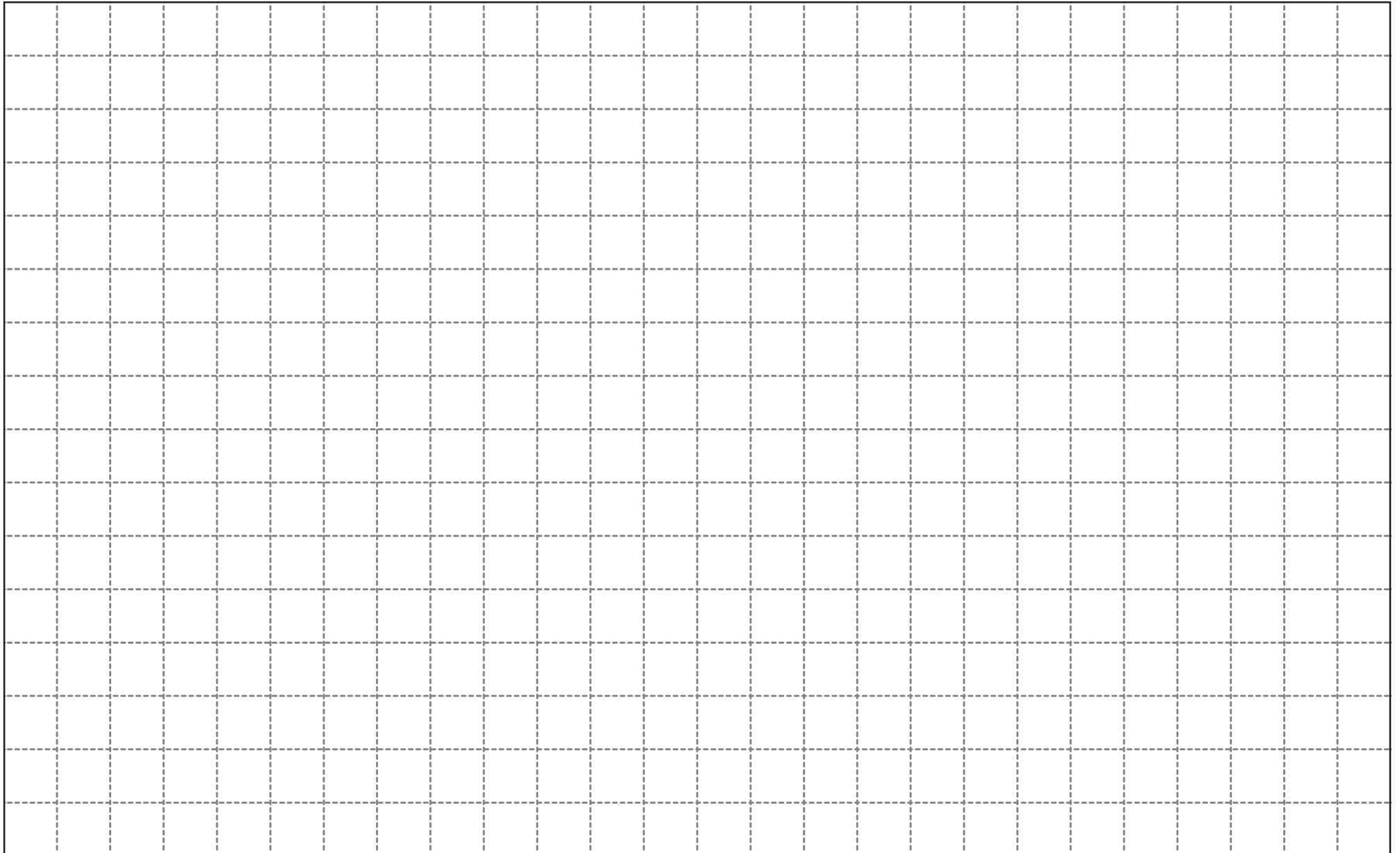

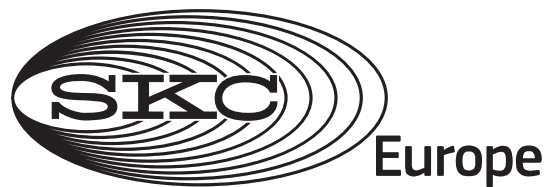

## Air Sampling Solutions & Expertise