

Air Sampling Basics

What is Air Sampling?	1
Types of Contaminant	2
mg/m ³ and ppm	3
How is Air Sampling Carried Out?.....	4
Dust Conventions	5
Sampling Devices.....	6
The Sample Train	7
Calibration	8
The SKC Air Sampling Pump Range.....	9
The IOM Sampler	10
Inhalable Dust Sampling using the IOM Sampler	11
Respirable Dust Sampling using the Cyclone Sampler	14
Gas & Vapour Sampling using Sorbent Tubes	18
Gas & Vapour Sampling using Impingers	21
Bag Sampling.....	25
Basic Formulae.....	27

A helping hand from the experts

This guide is designed as an introduction to the basic principles of air sampling methods and deals with the setting up of the equipment. Advice notes relating to specific sampling strategies, methods, and protocols can be obtained from the HSE (www.hse.gov.uk) and these will give you a good understanding of the approach you should take to sampling in your particular industry.

SKC equipment is suitable for many situations and applications beyond what is covered in this guide, and more information can be found on our website and in the pump manuals.

If you are new to air sampling, our one day training course 'A Practical Course in Air Monitoring' will give you the help you need to get started. The course includes both theoretical and practical sessions in the use of air sampling equipment. An experienced practitioner will offer valuable insights on air sampling and will assist with instrument configuration and calibration.

Contact SKC Limited customer services today for details on courses and available dates:

Phone: +44 (0) 1258 480188

Email: info@skcltd.com

Web: www.skcltd.com

What is air sampling?

Put simply, air sampling is capturing the contaminant from a known volume of air, measuring the amount of contaminant captured, and expressing it as a concentration.

This means that an air sample requires three basic measurements:

1. The flow rate of air through the collection medium
2. The sample run time
3. The amount of contaminant collected

The volume of air is calculated by multiplying the flow rate through the collection medium by the sample run time. It is important to know the exact volume of air sampled, so accurate calibration of the flow rate should be carried out before and after each sample is taken.

$$\text{Flow} \times \text{Time} = \text{Volume of air sampled}$$

The concentration is calculated by dividing the amount of contaminant collected by the volume of air sampled, and it is expressed either as milligrams per cubic metre (mg/m^3) or parts per million (ppm).

$$\text{Amount} \div \text{Volume} = \text{Concentration of contaminant}$$

Why perform air sampling?

Some substances present in workplaces can be harmful to health, so levels of exposure to these hazardous substances must be monitored to protect workers.

In the European Union, maximum exposure levels for these hazardous substances are set out in the current Indicative Occupational Exposure Limits Directive (IOELD). In the UK the guidance document for this is EH40/2005 Workplace Exposure Limits, and similar documents are produced in the other EU countries. EH40 specifies maximum exposure levels for substances that are deemed potentially harmful. These are referred to as Workplace Exposure Limits (WELs).

WELs are concentrations of hazardous substances in the air, averaged over a specified period of time, referred to as a time weighted average (TWA). Two time periods are used: Long term (8 hours) and short term (15 minutes). Short term exposure limits (STELs) are set to help prevent effects such as eye irritation, which may occur following exposure of only a few minutes. EH40 also highlights other important information about the substance, such as whether it is a skin sensitizer, carcinogenic, or whether biological monitoring guidance also applies.

It is important to note that substances that have been assigned a WEL are subject to the requirements of the UK Control of Substances Hazardous to Health (COSHH) Regulations, which require employers to prevent or control exposure to hazardous substances. For more information please visit www.hse.gov.uk/coshh.

There are three types of contaminant according to their physical properties:

- Particulates
- Vapours
- Gases

Particulates can be further subdivided into five types:

- Aerosols
- Dusts
- Fumes
- Smokes
- Mists
- Fibres

Contaminant Definitions	
Aerosol	Dispersion in air of solid particles of microscopic size.
Dust	Solid particulate capable of temporary suspension in air. Dusts are usually derived from larger masses through the application of physical force.
Fume	Solid particles produced by condensation from the gaseous phase. Fumes are usually derived from the intense heating of a solid (commonly metals) beyond its melting point, for example when welding. The intense heat vaporises some of the solid, and the fume is formed by the subsequent cooling of the gas produced.
Smoke	Particles resulting from the incomplete combustion of organic matter consisting predominantly of carbon and oxides of carbon.
Mist	Dispersion in air of liquid droplets usually large enough to be seen by the naked eye.
Fibre	Particles of natural or synthetic materials that are significantly longer than they are wide. Examples include asbestos and glass fibres.
Vapour	Gaseous phase of a substance that usually exists as a liquid or solid at normal room temperature and pressure.
Gas	A substance which does not normally exist as a liquid or solid at normal room temperature and pressure.

Concentrations are expressed as milligrams per cubic metre (mg/m³) for solids or parts per million (ppm) for gases.

It is not always easy to picture what 1mg/m³ or 1ppm actually means, so the diagrams below may help to get some idea of the scale. The analogies shown are approximate but do give a reasonable representation of concentration.

It is also possible to express concentrations of gas in mg/m³. A conversion formula is included in the BASIC FORMULAE section on page 27 of this guide.

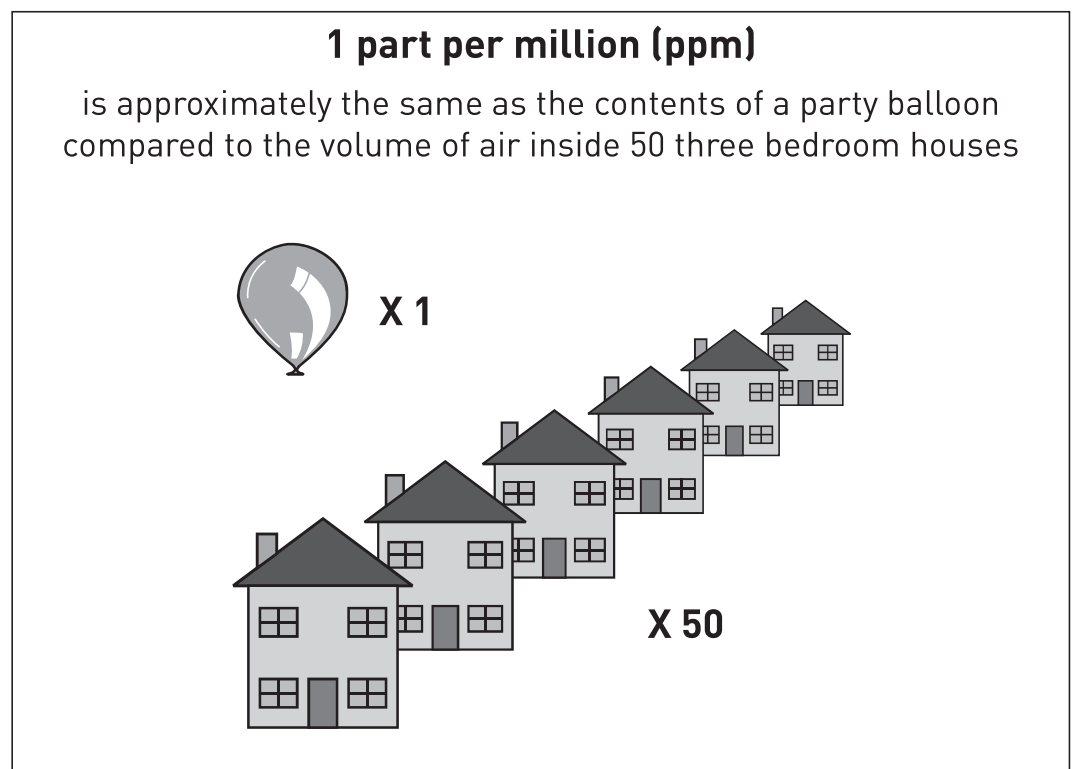
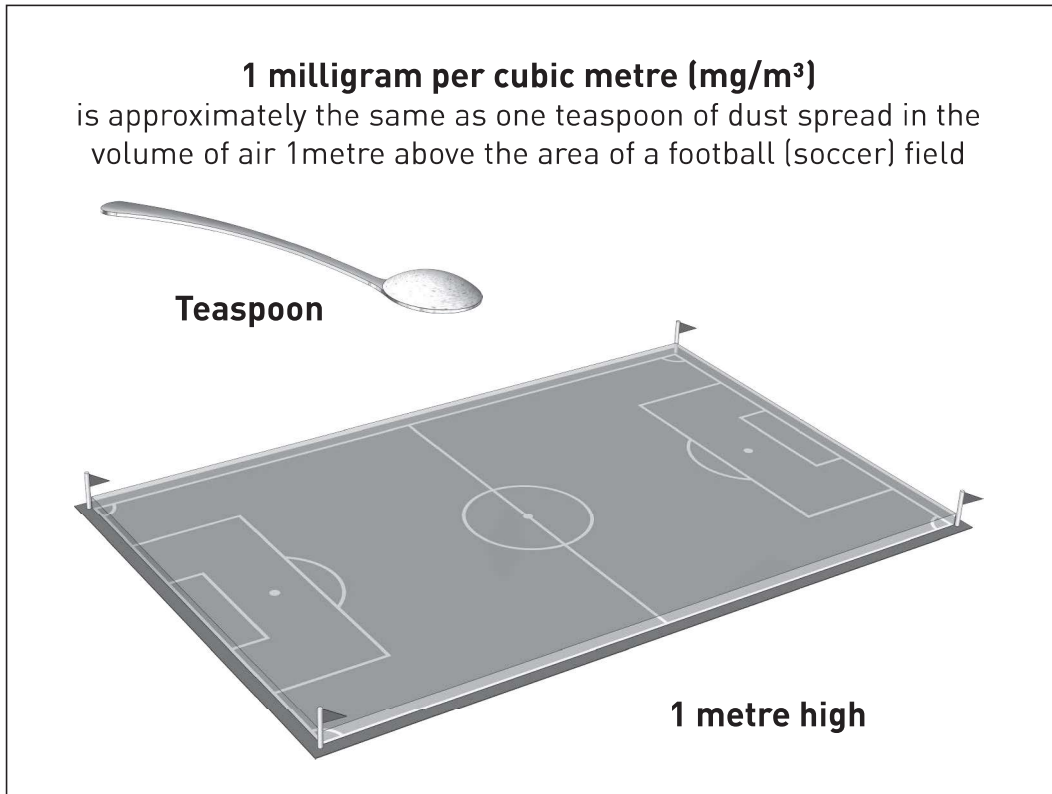

How is Air Sampling Carried Out?

There are many different methods of taking air samples, but by far the most common is to use a battery operated pump to draw a volume of air through a collection device ('sampler') which is mounted in the breathing zone of the worker.

As the air passes through the sampler, any contaminants present are captured onto a collection medium (normally a filter paper for solid contaminants and a sorbent for gases). The sample is then sent to a laboratory for analysis to calculate the concentration of the contaminant.

The UK Health & Safety Executive publishes guidance on the recommended methods of monitoring exposure to substances with a WEL: Methods for the Determination of Hazardous Substances, which can be found on their website www.hse.gov.uk. There are also some internationally adopted (ISO) standards that are used for some contaminants such as welding fume. To find the most appropriate sampling method for your hazard please consult the HSE website, the sampling guide in the SKC catalogue, or the online Hazard Search at www.skcltd.com/hazard-search.html.

Methods of monitoring must simulate actual exposure in order for the results to be compared with regulatory levels. This means that the sample must be a 'personal' sample, e.g. taken from within the employee's personal breathing zone (see image below).

The pump should be capable of drawing air through the sampler at the required flow rate for a set time period and constantly maintain that flow rate regardless of fluctuations in temperature or back pressure (the restriction to air flow of the sampler).

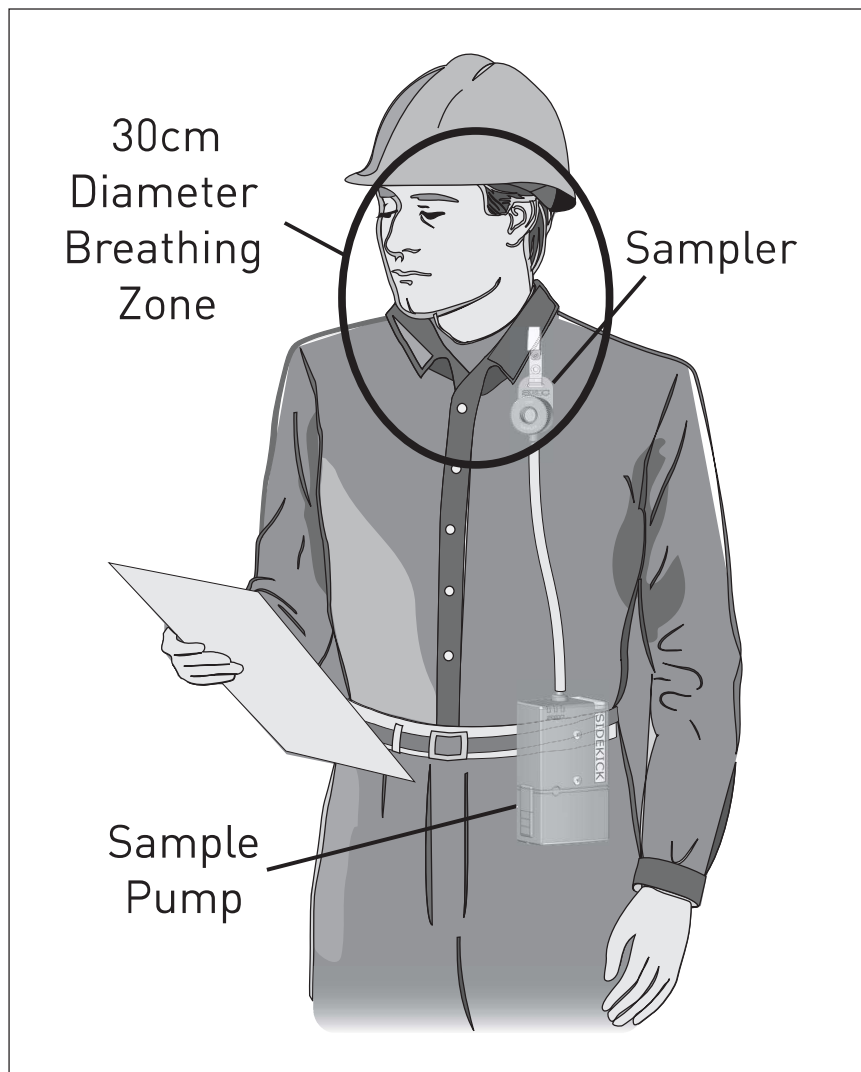

Dust or 'aerosol' is split into three size ranges as detailed in the diagram to the right, each of which has different effects on the respiratory system.

Inhalable dust is any solid particle which by its small size can be carried in airflow or remains airborne and can be inhaled through the nose and mouth.

Thoracic dust is taken to be solid particles which can be drawn past the larynx.

Respirable dust is taken to be solid particles which because of their extremely small size can be drawn deep into the lungs.

It is important to note that inhalable dust contains both thoracic and respirable particles, and in the same way thoracic dust contains respirable particles.

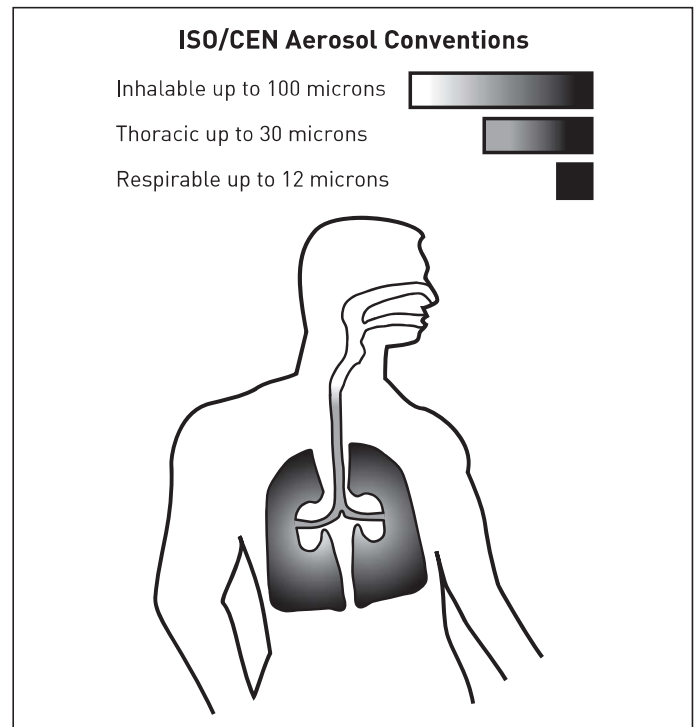

Historically, respirable dust has demanded the most attention as smaller particles can penetrate deeper into the lungs and cannot be ejected by the normal means of breathing out, coughing or travelling out in the lung mucus. It is because of this ability to stay in the body that it is considered to be dangerous; the particles can settle onto the lining of the lungs and cause respiratory illness such as silicosis or COPD (Chronic Obstructive Pulmonary Disease). However, particles of larger sizes can also have an effect on the upper respiratory tract (throat, nose, and mouth).

The conventions are described in detail in the European Standard EN481:1993 Workplace atmospheres - Size fraction definitions for measurement of airborne particles. The chart below (taken from EN481:1993) shows in detail the particle size distributions for the three conventions.

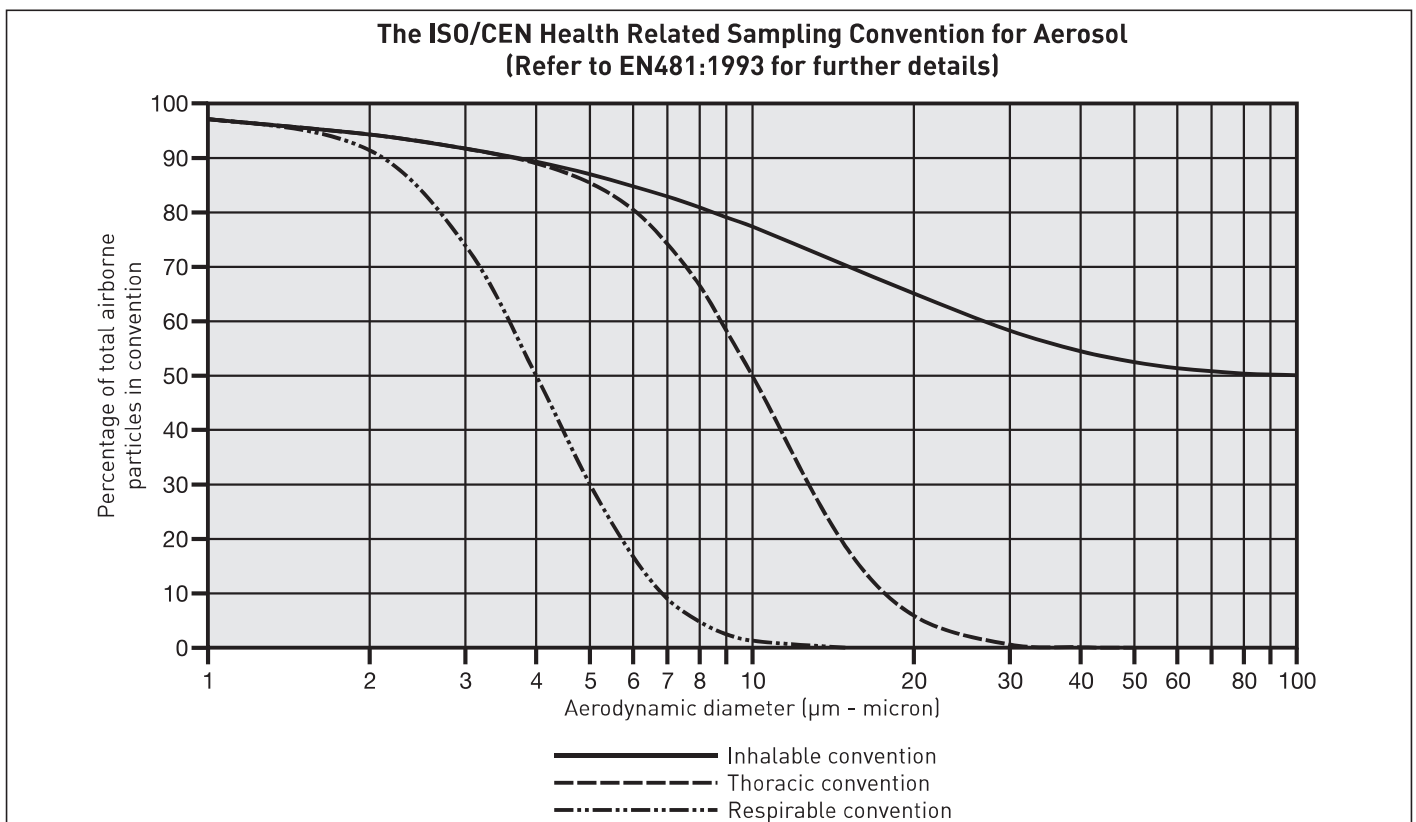

Filter Sampling Inhalable Dust

The design of the IOM* sampler inlet allows only the inhalable fraction to be drawn into the sampler where it is captured on a filter paper mounted inside a cassette as the air passes through the filter. Gravimetric analysis is usually used to measure results (i.e. by measuring the weight gain of the filter). Further analysis can be carried out on the filter to identify the specific chemicals captured.



Filter Sampling Respirable Dust

The IOM* sampler with a special foam plug placed in the cassette inlet can be used to sample respirable dust. The foam plug captures the larger dust particles but allows the finer respirable dust to pass through to be captured on the filter paper.



Filter Sampling Respirable Dust (Alternative Method)

The Cyclone Sampler uses a cyclonic action to separate out the fine respirable dust which is captured on a filter paper mounted inside a cassette at the top of the sampler. The larger dust particles drop into a 'grit pot' mounted at the bottom of the sampler.

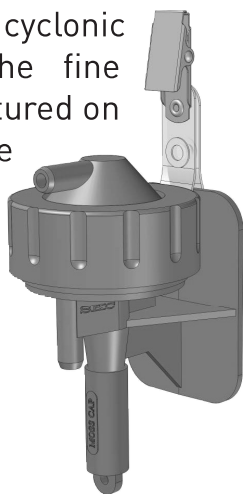

*Manufactured under license from the Institute of Occupational Medicine TM 2043339E

Sorbent Sampling

Sorbents are normally contained in a small glass tube with sealed ends. Air is drawn through the sorbent, which adsorbs molecules of the gas or vapour to be sampled. The trapped contaminants are released from the sorbent (desorbed), for laboratory analysis, using solvent washing or heat. One of the most common sorbents is activated charcoal.



Bag Sampling

Particularly suitable for 'grab' or Short Term Samples (STS), the air is passed through a sample pump into a special plastic bag. Alternative methods of filling a bag without passing air through a pump can also be used. The bag, containing a relatively large volume of sampled air, is then taken to the laboratory for analysis.



Impinger/Bubble Sampling

Air drawn into the impinger is forced through a nozzle, which is covered by a liquid such as high purity water. The pollutant dissolves in the liquid and is subsequently analysed, usually by colorimetric techniques.

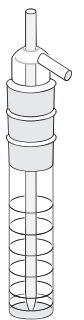

Other Methods

There are alternative samplers to those shown above, including combinations of tube & filter, impinger and special samplers for specific uses such as chemically impregnated filters and passive badges. Details of all of these methods can be found in the SKC catalogue or on our website. To order your copy of our catalogue please contact our customer services team on +44 (0) 1258 480188, or request a copy using the SKC Ltd website.

The sample train is the name given to the combination of a pump, flexible tube and sampling device when connected together. The figures below give examples of sampling trains.

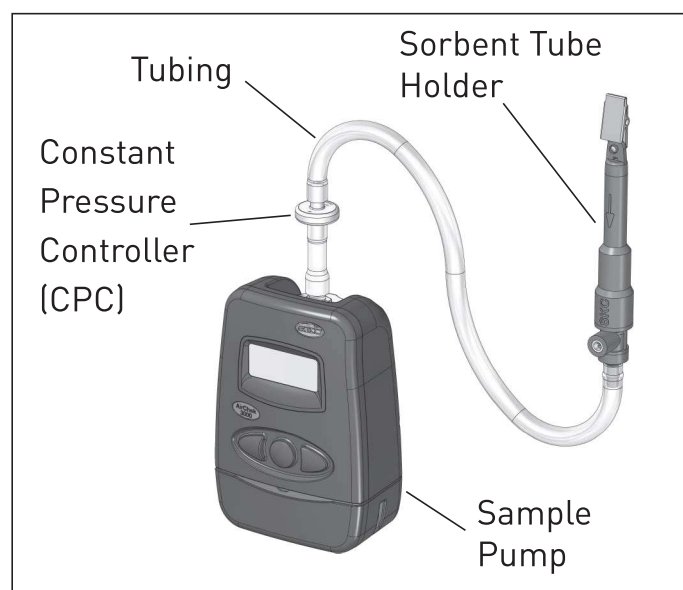
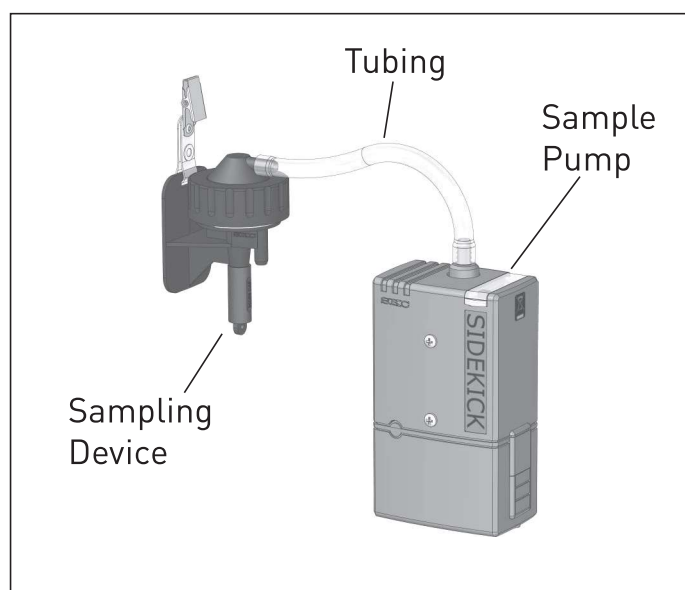

Sample Train Check List

- Ensure the pump is fully charged.
- Treat the collection media with care.
- Calibrate in a clean area to avoid contamination of the collection media.
- Ensure the flow rate is set at the correct level required for the sampling device or methodology.
- Ensure that all connections are leakproof and secure.
- Mount the sampler in the “breathing zone”.
- Ensure the flexible tube is not left to hang free.
- Note the start and finish time.

And finally...

- Always note the sample start and stop time.
- Don't forget to record the sample media, person sampled, time, date and location together, preferably on a form.
- Remember – the result is only as good as the sample taken.

Calibration of the air flow rate through the sampling system is important and should be checked before AND after every sample is taken (see MHDS 14/4).

Most published sampling methods specify a minimum level of accuracy for the flowmeter to be used.

For high accuracy combined with ease of use, an electronic instrument, such as the chek-mate flowmeter is recommended. The chek-mate is an orifice type flow meter which determines the air flow rate based on the pressure drop across the orifice, and displays the measured flow rate on an LCD screen. The chek-mate automatically corrects for changes in the ambient temperature and barometric pressure, has high accuracy across its entire air flow range and can be used in any orientation.

An alternative, less accurate option is the variable area (VA) flowmeter, commonly referred to as 'rotameters'. The flow rate is indicated by the position of a float inside a graduated glass tube. The graduated scale is standardised to a particular temperature and pressure, e.g. 20°C and 1atm (1013.25mbar). If the actual air temperature and barometric pressure differ from these values when using the rotameter, an error is introduced to the reading. The reading should be corrected for this error requiring additional instruments to measure the air temperature and barometric pressure. The accuracy of rotameters is best at the top of the scale and reduces significantly below this point.

For laboratory use, as against calibration 'in the field', a bubble film flowmeter may be used. The flow is calculated by timing a bubble between two graduation marks on a glass tube using a stopwatch.

The majority of dust sampling applications are performed at flow rates between 1 and 5 litre/min. The majority of gas sampling applications are performed at flow rates between 20 and 500 ml/min. Ensure that the flowmeters you choose are suitable for measuring the required flow rates.

chek-mate Flowmeter



Rotameter



Bubble Film Flowmeter



SKC offer a comprehensive range of pumps. Please visit our website or contact SKC to decide which pump is most suitable to meet your sampling requirements.

In the following pages, the Sidekick sample pump has been used to illustrate the sampling procedures. However, any of the pumps shown may be substituted if the pump operates at the required flow rate. The exception is the Pocket Pump Touch, a 'low flow' pump which is specifically designed for gas and vapour sampling only.



Sidekick

- Simple to use
- ATEX certified models
- Simple timer model



Universal

- Built in flow indicator
- Built in low flow regulator
- Exhaust port for bag sampling
- Programmable model
- ATEX certified



AirChek 3000

- Programmable
- CalChek automatic flow calibration
- DataTrac PC software
- ATEX & IECEx certified



AirLite

- Compact and lightweight
- Simple to use
- Uses disposable alkaline batteries



AirChek Touch

- Colour touch screen display
- Programmable
- Calchek automatic flow calibration
- DataTrac Pro PC software



AirChek XR5000

- Wide flow range
- Programmable
- Up to 40 hours run time
- Compact and lightweight model



Pocket Pump Touch

- Small and compact design
- Touch screen display
- Programmable
- Bluetooth™
- DataTrac Pro PC software
- ATEX & IECEx certified



AirChek Connect/Essential+

- Touch screen display
- Simple to use
- Programmable#
- Bluetooth™#
- DataTrac Pro PC software#
- ATEX & IECEx certified

AirChek Connect only

SKC Pump	Sampling Type		Flow Setting Method	Flow Range
	Dust	Gas/Vapour		
AirLite	Yes	Yes*	Manual adjuster screw	1 to 3 litre/min
Sidekick	Yes	Yes*	Manual adjuster screw	0.75 to 3 litre/min
Universal	Yes	Yes	Manual adjuster screw	1 to 4 litre/min
AirChek 3000	Yes	Yes*	Keypad & LCD screen	1 to 3.25 litre/min
AirChek XR5000	Yes	Yes*	Keypad & LCD screen	1 to 5 litre/min
AirChek Touch/Connect/ Essential+	Yes	Yes*	Touch screen	1 to 5 litre/min
Pocket Pump Touch	No	Yes	Touch screen	20 to 500 ml/min

* To use for gas/vapour sampling at flow rates in the range 5 to 500 ml/min these pumps require a CPC (Constant Pressure Controller) or All-in-One adjustable low flow adapter.

The IOM sampler is designed and closely adheres to the definition for inhalable dust given in EN481.

IOM stands for the “Institute of Occupational Medicine”. Based in Edinburgh, researchers at the Institute developed this sampler to overcome some of the difficulties encountered with other sampling devices. It is less prone to the effects of air movement around it than others and utilises a cassette rather than just a filter paper. There is a very good reason for the cassette system being adopted. One of the problems with other devices using a filter paper alone is loss of sample on the walls of the sampler itself. The dust which coats the walls of the sampler is not normally included in the results, hence under-sampling is a possibility. With the IOM sampler this problem is overcome by using a cassette with the filter inside.

It is important that when a sample is taken the cassette and filter paper are pre and post weighed as a single unit. By doing this all the dust on both the filter paper and on the internal walls of the cassette are included.

The diagram below shows the component parts of the sampler and how they are put together.

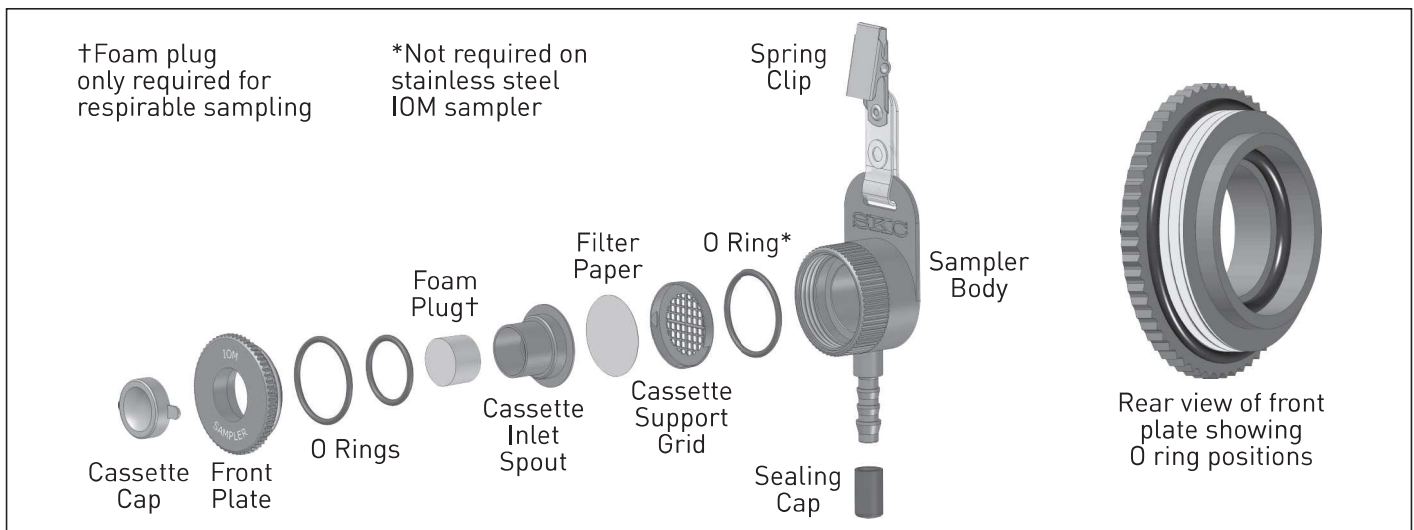

To fit a filter unscrew the front plate. The cassette, comprising the inlet spout and filter support grid can now be removed by pulling forward gently. The two halves of the cassette clip together and can be separated with gentle pressure. Once separated a filter can be placed in the support grid. Snap the inlet spout into the support grid making sure it is seated down properly. The cassette is replaced into the body of the sampler and the front plate screwed on firmly so that all of the O ring seals are compressed, thus ensuring there are no leaks.

Dust Sampling – Inhalable and Respirable

The IOM sampler can also be used for respirable dust sampling by inserting a foam plug into the inlet spout part of the cassette. The foam plug collects the larger inhalable particles of dust drawn through it and allows the smaller respirable dust to be collected on the filter. It is possible to measure both the inhalable and respirable dust fractions in one sample using the foam plug and IOM cassette.

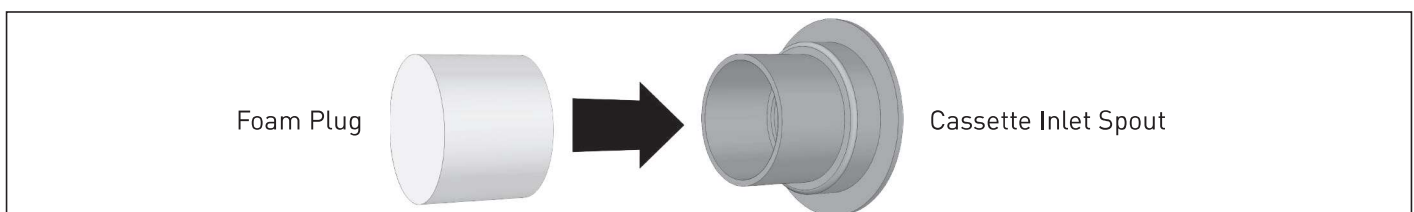

You will need :-

- Sample pump (fully charged)
- IOM sampler
- A length of flexible tubing
- Two filter papers from the same box or batch
- Flow calibration device capable of measuring 2 litre/min
- 'Calidaptor' calibration adaptor for the IOM sampler
- Toolkit to adjust the pump flow rate (for pumps with manual flow adjustment)

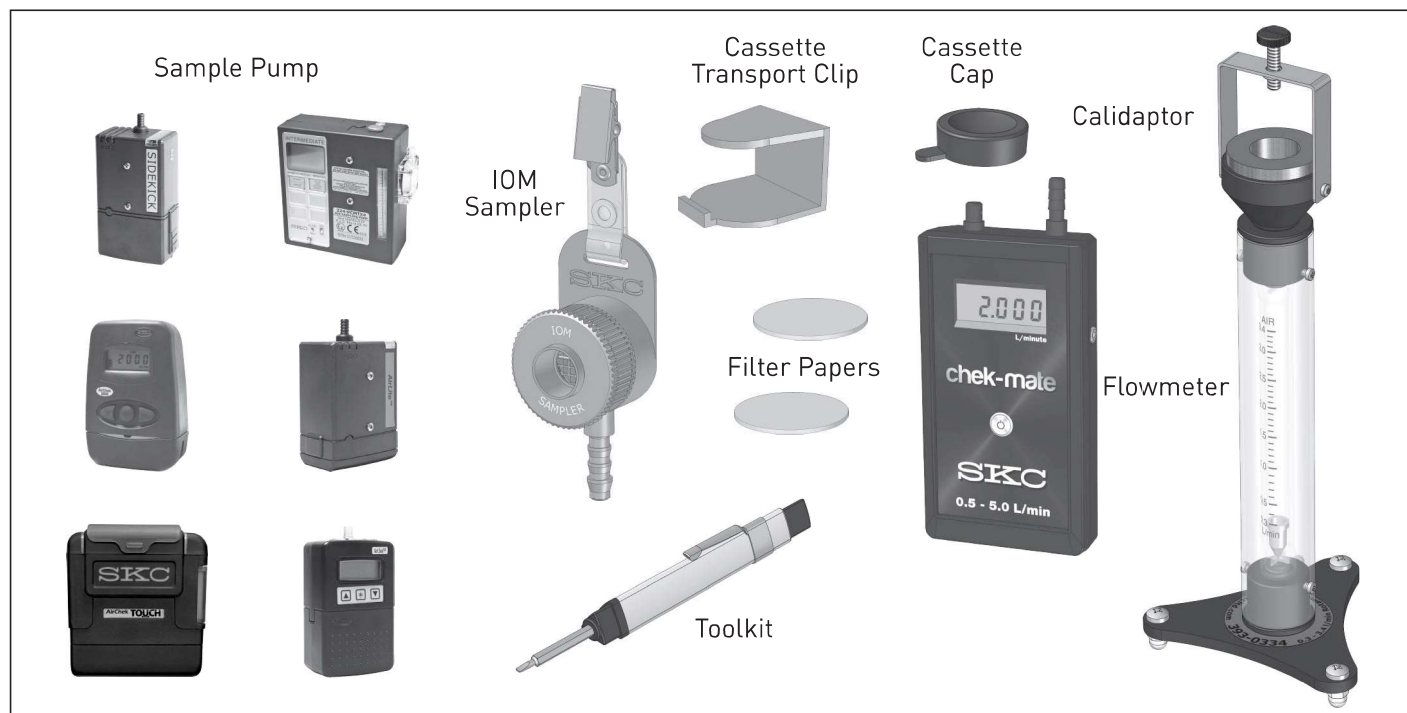

The correct flow rate for the IOM sampler is 2.0 litre/min

1. Mount one of the filter papers into the IOM cassette. Place the cassette into the sampler body and screw on the front cover.
2. Connect the the outlet hosetail of the IOM sampler, with filter paper fitted, to the inlet hosetail of the sample pump with a length of flexible tubing.
3. To set the flow rate required use a flowmeter such as a chek-mate or a rotameter. Make sure the flowmeter is capable of measuring the required flow rate. The IOM sampler requires a calibration adaptor or 'calidaptor' for this process.
4. The IOM sampler is placed onto the foam sealing pad on the top of the calidaptor. Secure the IOM sampler to the calidaptor using the finger screw, ensuring a good seal of the front face of the IOM sampler to the foam pad. The hosetail fitting supplied with the calidaptor is screwed into the hole in the bottom of the calidaptor. The calidaptor hosetail is connected to the outlet hosetail on the chek-mate



flow calibrator, with the length of tubing supplied with the calidaptor. Turn on the chek-mate flow calibrator.

5. If using a rotameter to set the flow rate, the calidaptor is designed to screw directly into the outlet at the top of SKC 393 series rotameters. Unscrew the hoesetail fitting supplied fitted to the rotameter, and screw the calidaptor into the threaded hole in the top of the rotameter, fastening tightly to ensure a good seal of the calidaptor O ring. If using a non-SKC rotameter, use the hoesetail fitting and length of tubing supplied with the calidaptor to connect the calidaptor to the rotameter. Fit the IOM sampler to the calidaptor and secure with the finger screw.

6. The flow rate is adjusted either manually or electronically, depending on the sample pump being used. Switch the pump on and follow the procedure in the sample pump manual. In the case of the Sidekick, Universal and AirLite pumps use the screwdriver tool to turn the flow adjustment screw. For the AirChek 3000, XR5000 and Touch pumps use the keypad or touch screen to set the flow rate. As the flow rate is adjusted the flow reading on the flowmeter should increase or decrease. If this does not happen check the system for leaks or blockages. One common cause of lack of flow occurs by using the separation papers (usually coloured blue) included in some packs of filters instead of the filters themselves (usually coloured white). If using a rotameter, be sure you are reading it correctly. Take the reading at the top edge of the float, as shown. Ensure that the float is stable and spinning in the airflow, thus showing that it is not touching the walls of the rotameter tube which could affect the accuracy of the reading. Note that the rotameter must be placed onto a flat, level surface to ensure that the float does not touch the sides of the rotameter tube. Once the flow is set to the required level of 2.0 litre/ min, switch the sample pump off.

7. Remove the IOM sampler from the calidaptor and then remove the filter cassette from the sampler. Remove the filter paper from the cassette, and ensure that the cassette inlet spout and support grid are clean and free of contamination. Fit the second filter paper into the cassette. Pre-weigh the filter and cassette, and then fit the cassette back into the IOM sampler. Check the flow once again with the pre-weighed filter and cassette

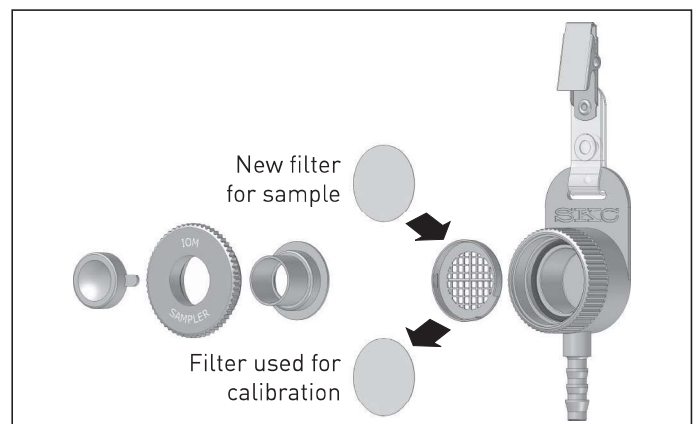
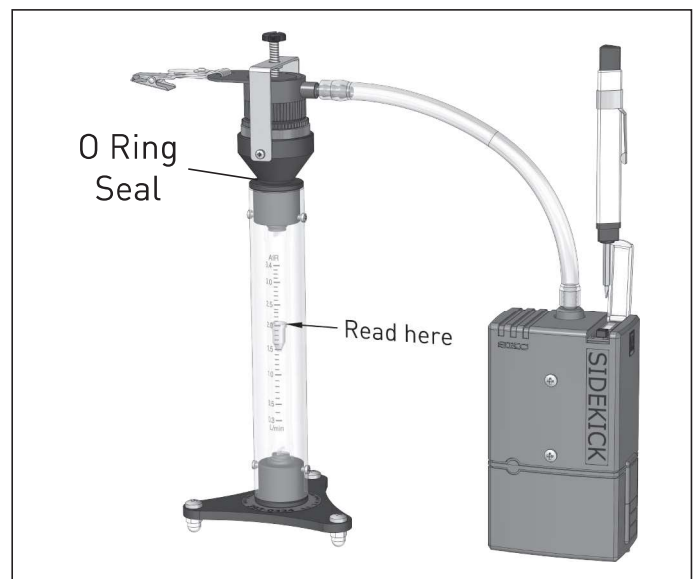
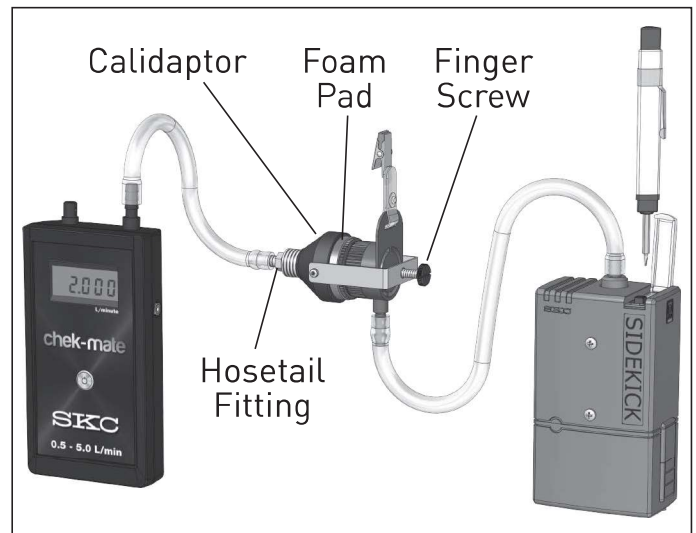

in place and make any final adjustments needed to bring the flow to the required level. It is advisable to do this as quickly as possible to minimise the chance of collecting anything that may affect the final result. The IOM sampler, complete with the new filter, should now be fitted with the cassette cover supplied, and is ready to take into the workplace.

8. Mount the sample train (comprising the sample pump, tubing and IOM sampler) onto the worker who is to wear it during the sample. The IOM sampler should be mounted as close to the breathing zone

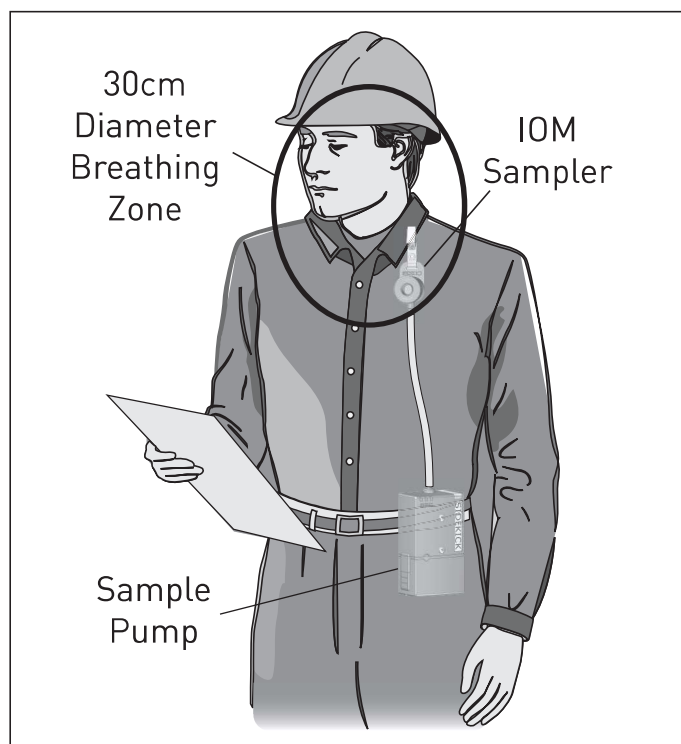

as is practical and comfortable. The pump can either be clipped to a belt or placed into a pouch. Note that the connecting tubing can present a hazard if left to flap around, so measures should be taken to protect the wearer by securing the tubing. Once the pump is mounted on the worker in a satisfactory way, remove the cassette cover and switch on the pump.

IMPORTANT: The start time of the sample should be noted.

9. At the end of the sample switch off the pump, replace the cassette cover and note the finish time of the sample. Remove the sample train from the worker, and once away from the sample location re-check the flow rate of the sample pump (as per MDHS 14/4). Ensure that the flow rate check is carried out as quickly as possible to minimise the chance of collecting anything that may affect the final result. Remove the filter cassette from the IOM sampler and post weigh the filter and cassette.

If the sample is to be sent to a laboratory for further analysis, refit the cassette cover and fit a cassette transport clip.

The start and finish times, sample duration, worker's name, start and finish flow rates, pre and post sample weights and any other relevant details of the sample should be noted down and indexed to the filter paper or cassette by number or code.

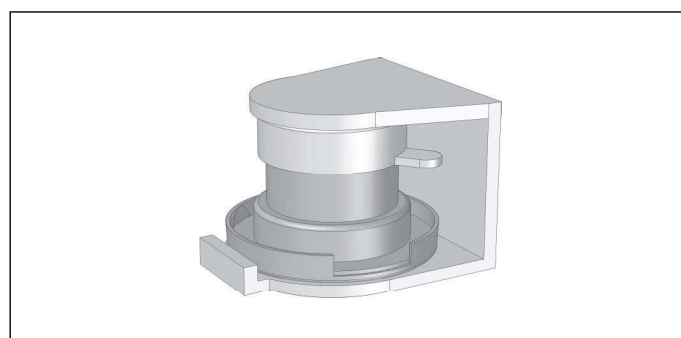

You will need :-

- Sample pump (fully charged)
- Cyclone sampler and cassette
- Two lengths of flexible tubing
- Two filter papers from the same box or batch (one of which is pre-weighed)
- Flow calibration device capable of measuring 3 litre/min
- Toolkit to adjust the pump flow rate (for pumps with manual flow adjustment)
- Filter transport cassette



The correct flow rate for the Cyclone sampler is 3.0 litre/min

1. Mount the filter paper that is not pre-weighed into the cyclone cassette as shown in the diagram. The easiest way is to place the filter in the cassette as follows. Remove the top half of the cassette and place it upside down on a flat surface, so that it looks like a shallow bowl. Place the filter support grid into the cassette top and place the filter on the grid. Carefully pick up the cassette top with grid and filter, and snap the cassette bottom onto the cassette top. By assembling the filter cassette in this way the filter remains located centrally on the support grid.

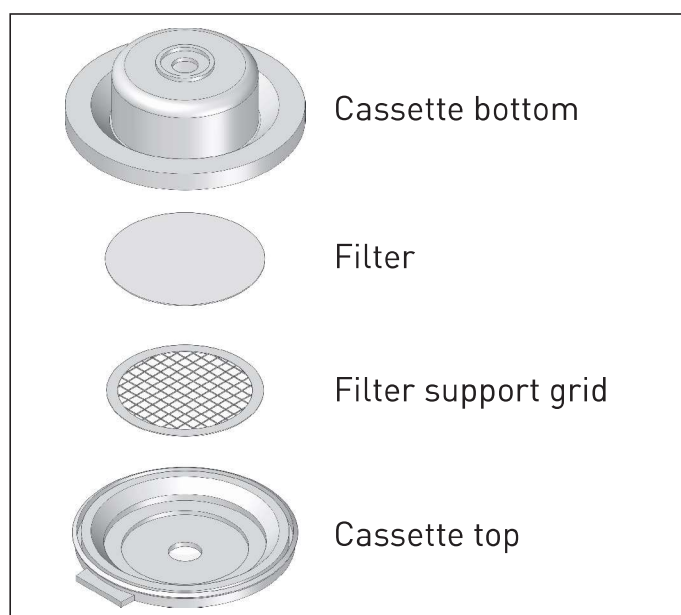

2. Place the filter cassette into the cyclone sampler body, mounting it with the embossed text 'SKC TOP' facing upwards as shown in the figure to the right. Check that an O ring is fitted into the circular slot in the bottom face of the sampler top, fit the sampler top over the cassette and secure with the retaining ring, tightening firmly to ensure a good

seal. Make sure the grit pot is fitted to the bottom of the cyclone sampler.

3. Connect the top tubing connector (air outlet) on the cyclone sampler to the inlet hosetail on the sample pump with a length of flexible tubing.

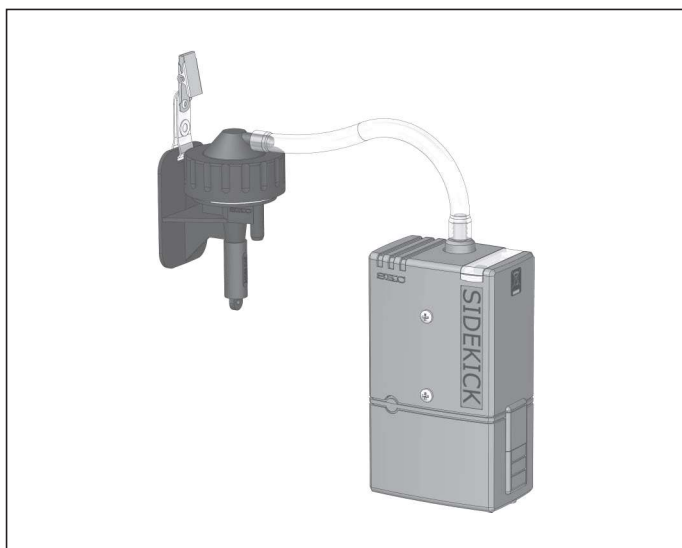

4. To set the flow rate to the required 3.0 litre/min for the cyclone sampler, a flow calibration device such as a chek-mate flowmeter or a rotameter should be used. Make sure the flow calibrator is capable of measuring the required flow rate.
5. If using the chek-mate flowmeter connect the air inlet of the cyclone sampler to the outlet hosetail on the chek-mate with a length of tubing, as shown. Turn on the chek-mate flowmeter.



6. If using a rotameter to set the flow rate, connect the air inlet of the cyclone sampler to the hosetail on the top of the rotameter using a length of tubing. If a 'calidaptor' is fitted to the rotameter, screw the threaded hosetail fitting supplied with the calidaptor into the threaded hole in the bottom of the calidaptor 'bowl', and connect the cyclone sampler air inlet to the hosetail. Be sure you are reading the rotameter correctly. Take the reading at the top edge of the float, as shown. Ensure that the float is stable and spinning in the airflow, thus showing that it is not touching the walls of the rotameter tube which could affect the accuracy of the reading. Note that the rotameter must be placed onto a flat, level surface to ensure that the float does not touch the sides of the rotameter tube.

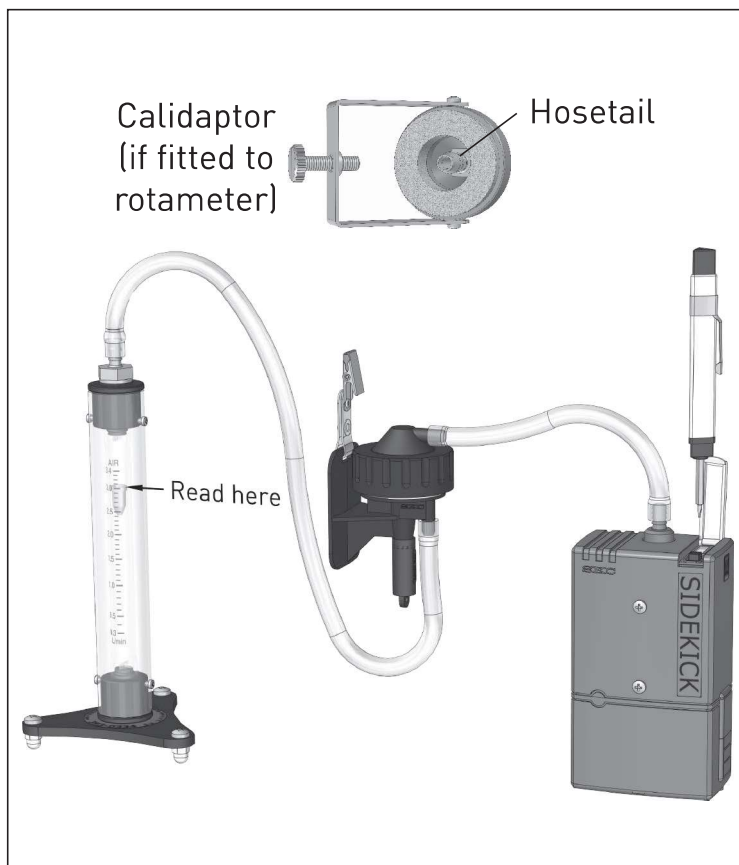

7. The pump flow rate is adjusted either manually or electronically, depending on the sample pump being used. Switch the pump on and follow the procedure in the sample pump manual. In the case of the Sidekick, Universal and AirLite pumps use the screwdriver tool to turn the flow adjustment screw. For the AirChek 3000, XR5000 and Touch pumps use the keypad or touch screen to set the flow rate. As the flow rate is adjusted the flow reading on the flow calibrator should increase or decrease. If this does not happen check the system for leaks or blockages. One common cause of lack of flow occurs by using the separation papers (usually coloured blue) included in some packs of filters instead of the filters themselves (usually white). Once the flow is set to the required level of 3.0 litre/min switch the sample pump off.

8. Remove the filter cassette from the cyclone sampler body, replace the filter paper in the cyclone cassette with the pre-weighed filter paper, and refit the cassette into the cyclone sampler. Check the flow rate once again with the pre-weighed filter in place and make any final adjustments needed to bring the flow to the required level. It is advisable to do this as quickly as possible to minimise the chance of collecting anything that may affect the final result. The cyclone sampler is now ready to take into the workplace.

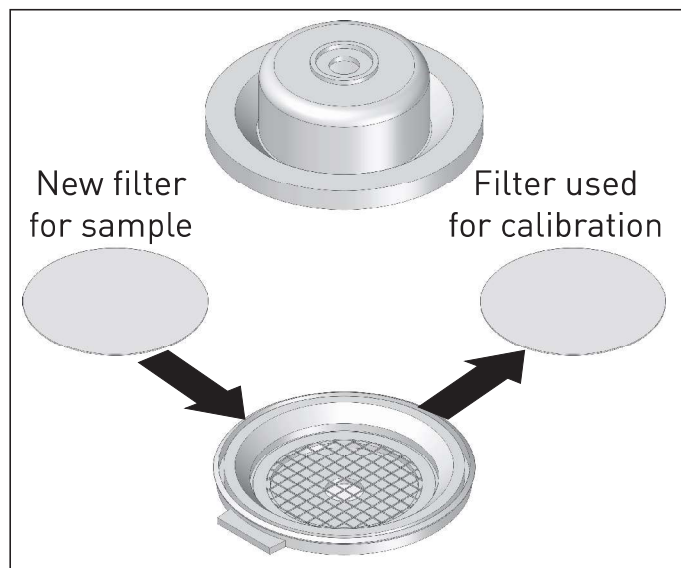

9. Mount the sample train (comprising the sample pump, tubing and cyclone sampler) onto the worker who is to wear it during the sample. The cyclone sampler should be mounted as close to the breathing zone as is practical and comfortable. The pump can be either clipped to a belt or placed into a pouch. Note that the connecting tubing can present a hazard if left to flap around, so measures should be taken to protect the wearer by securing the tubing. Once the pump is mounted on the worker in a satisfactory way it can be switched on.

IMPORTANT: The start time of the sample should be noted.

10. At the end of the sample switch the pump off and note the finish time of the sample. Remove the sample train from the worker, and once away from the sample location re-check the flow rate of the sample pump (as per MDHS 14/4). Ensure that the flow rate check is carried out as quickly as possible to minimise the chance of collecting anything that may affect the final result. Remove the filter cassette from the cyclone sampler. Open the filter cassette, carefully lift out the filter and post weigh it. If the sample is to be sent to a laboratory for further analysis, carefully transfer the filter onto the support grid in a transport cassette and snap the transport cassette shut. The start and finish times, sample duration, worker's name, start and finish flow rates, pre and post sample weights and other relevant details of the sample should be noted down and indexed to the filter paper by number or code.

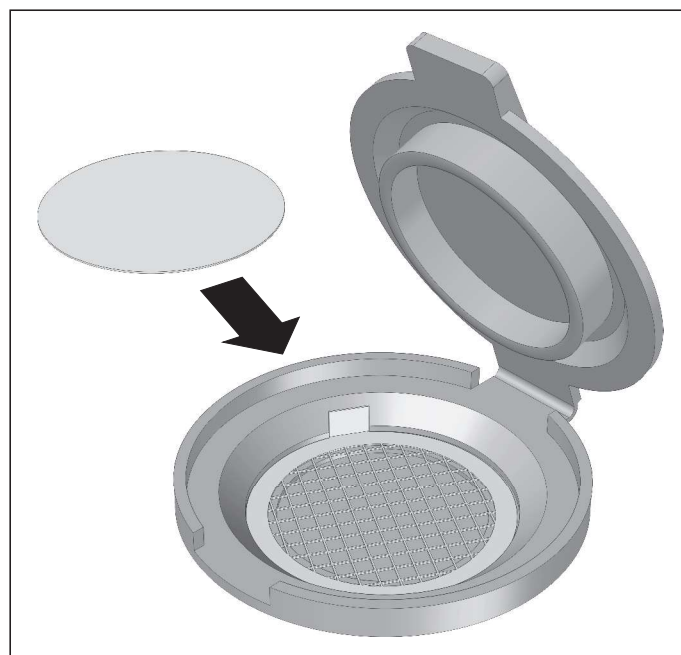
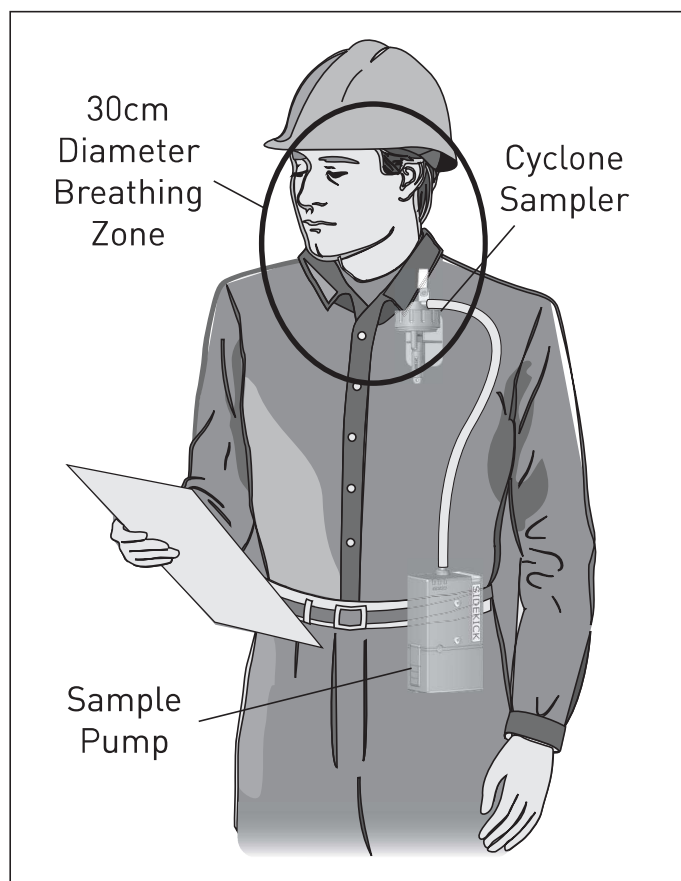

You will need :-

- Sample pump (fully charged)
- Either constant pressure controller (CPC) and adjustable low flow tube holder, or All-in-One low flow single tube holder
- **Note:** Universal pumps require the adjustable low flow tube holder only. Pocket Pump Touch requires a non-adjustable low flow tube holder only.
- Tube cover of appropriate size for the sorbent tube being used
- A length of flexible tubing
- Tube adapter for small diameter sorbent tube
- Two sorbent tubes from the same box or batch
- Flow calibration device capable of measuring the required flow rate, typically between 5 and 500 ml/min
- Toolkit to adjust the pump flow rate (for pumps with manual flow adjustment)



1. Connect the flowmeter directly to the sample pump inlet hosetail using a length of tubing. Turn on the pump and adjust the flow rate to 1.5 litre/min, as detailed on page 12, step 6 of this Guide. This is the required flow rate for correct operation of the Constant Pressure Controller (CPC) or All-In-One tube holder and also the Universal pump's built-in low flow pressure regulator. Switch off the pump and disconnect the flowmeter.

No further adjustment of the pump flow rate should be made.

Note: This step is not required if using the Pocket Pump Touch.



- Most sample pumps, with the exception of the Universal and Pocket Pump Touch, require a constant pressure controller (CPC) for low flow sampling. However, if using an All-in-One tube holder, the CPC is built into the tube holder and a separate CPC is not required.

If using a CPC, connect it to the pump. The short length of tube supplied attached to the CPC is connected to the pump inlet hosetail. This puts the pump into the low flow mode and allows use of the adjustable low flow tube holder.

The Universal pump incorporates a low flow pressure regulator which provides the same function as the CPC. Put the pump into low flow mode (refer to the pump instructions), unless using an All-in-One tube holder.

The Pocket Pump Touch is a low flow pump and can therefore be used without a CPC.

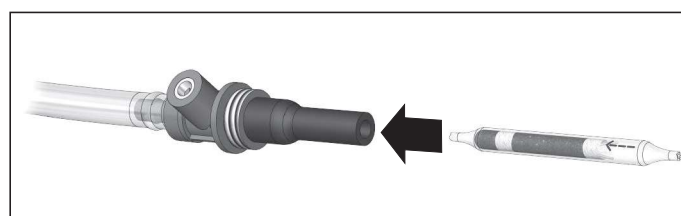
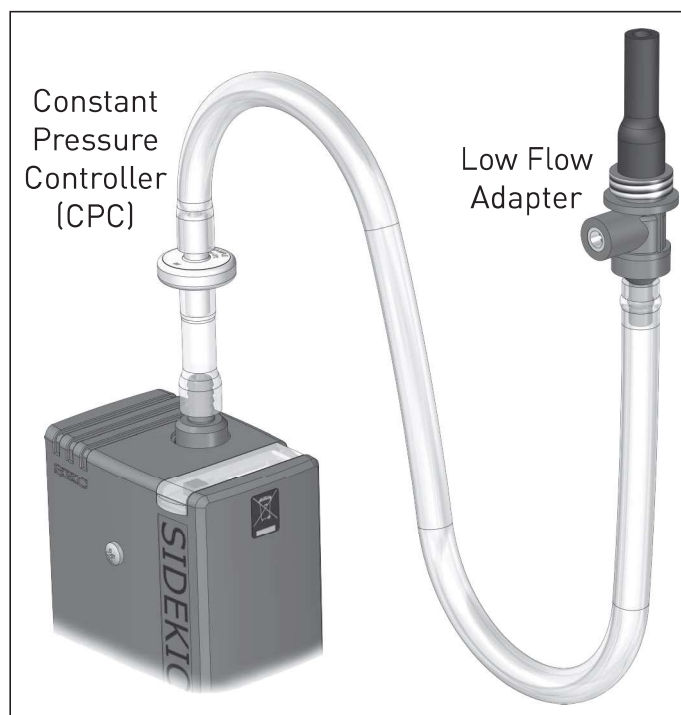

- The adjustable low flow tube holder is now connected to the free end of the CPC using the long length of tubing. As a further check that the connections are correct, the labelled side of the CPC should be on the side connected to the tube holder. If an All-in-One tube holder is being used the long length of tubing is connected directly to the pump inlet hosetail.

When using the Pocket Pump Touch a non-adjustable low flow tube holder that does not incorporate a throttle valve should be used and connected directly to the pump inlet hosetail.

- Take one of the sorbent tubes and break off both ends, ideally using a purpose designed tube tip breaker. Take care handling the tube as the broken ends are extremely sharp. Fit the sorbent tube into the short black hose of the low flow tube holder. To determine the correct way the sorbent tube should face, look for a printed arrow on the tube. The arrow represents the correct direction of the airflow through the tube. If present the arrow should point towards the pump. If there is no arrow on the tube, the largest air gap or unfilled section of the tube should face away from the pump, that is, to atmosphere.

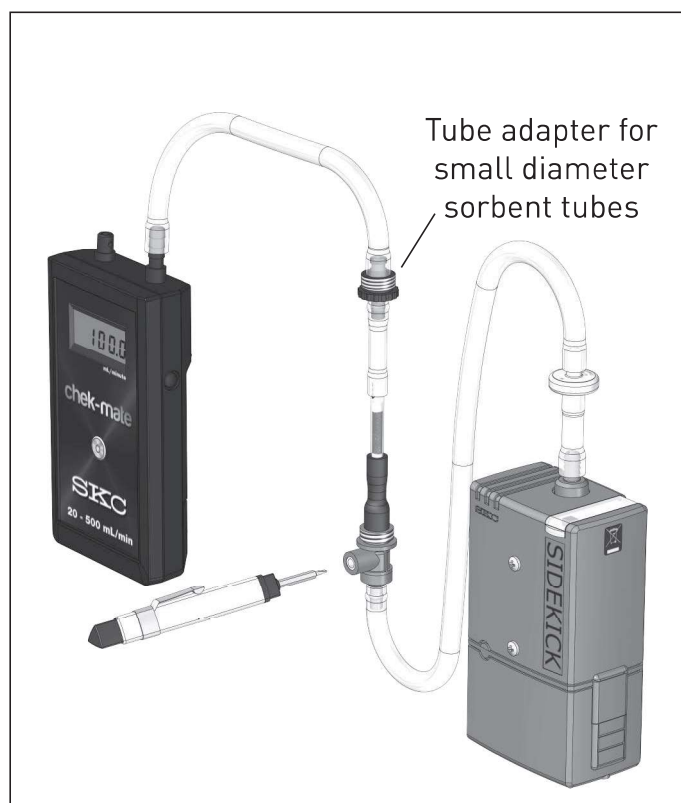

5. With the sorbent tube in place in the low flow tube holder a connection from the free end of the sorbent tube is made to the outlet hoesetail on the flowmeter, as shown. For small diameter sorbent tubes use the tube adapter to make the connection to the free end of the sorbent tube. Switch on the pump and flowmeter. **Ensure that the sorbent tube is held vertically during calibration.** Adjust the air flow rate through the sorbent tube by turning the throttle valve screw in the side of the low flow tube holder using the large bladed screwdriver attachment of the toolkit, as shown. Once the flow rate is set to the required level (depending on the tube type and sampling method), switch off the pump.

When using the Pocket Pump Touch with a non-adjustable tube holder, the flow rate through the sorbent tube is set on the pump via its touch screen.

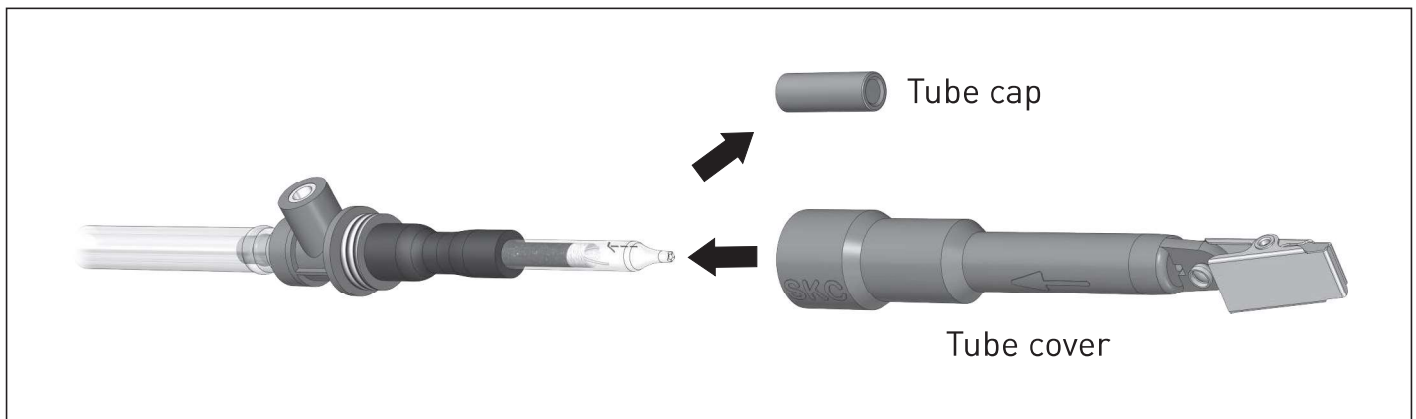

6. The sorbent tube used to set the flow rate is now removed from the tube holder and replaced with a clean tube with both ends broken off. The exposed end of the tube should be protected with the tube cover, which screws onto the low flow tube holder. One of the red plastic caps provided can be used to seal the sorbent tube until the sample is taken. However, please note that the cap should not be pressed on too far as they are designed to provide an airtight seal for transportation. Once pushed fully home the caps require cutting off with a sharp knife.

7. Mount the sample train (comprising the sample pump, tubing, tube holder and tube cover) onto the worker who is to wear it during the sample. The tube holder should be mounted vertically on the worker, and as close to the breathing zone as is practical and comfortable. The pump can be either clipped to a belt or placed into a pouch. Note that the connecting tubing can present a hazard if left to flap around, so measures should be taken to

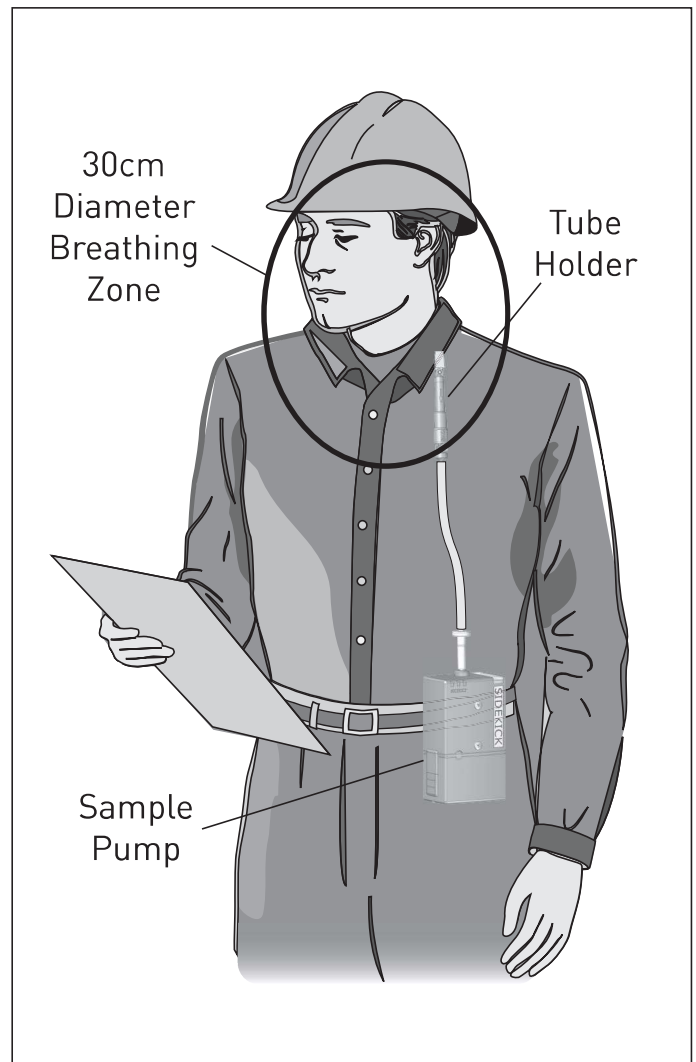

protect the wearer by securing the tubing. Once the pump is mounted on the worker in a satisfactory way it can be switched on.

IMPORTANT: The start time of the sample should be noted.

- At the end of the sample switch the pump off and note the finish time of the sample. Remove the sample train from the worker, and once away from the sample location re-check the tube flow rate. Ensure that the flow rate check is carried out as quickly as possible to minimise the chance of collecting anything that may affect the final result. When the sorbent tube is removed from the tube holder, both ends of the tube should be immediately capped with the red covers supplied. The start and finish times, sample duration, worker's name, start and finish flow rates and any other relevant details of the sample should be noted down and indexed to the sorbent tube by number or code.

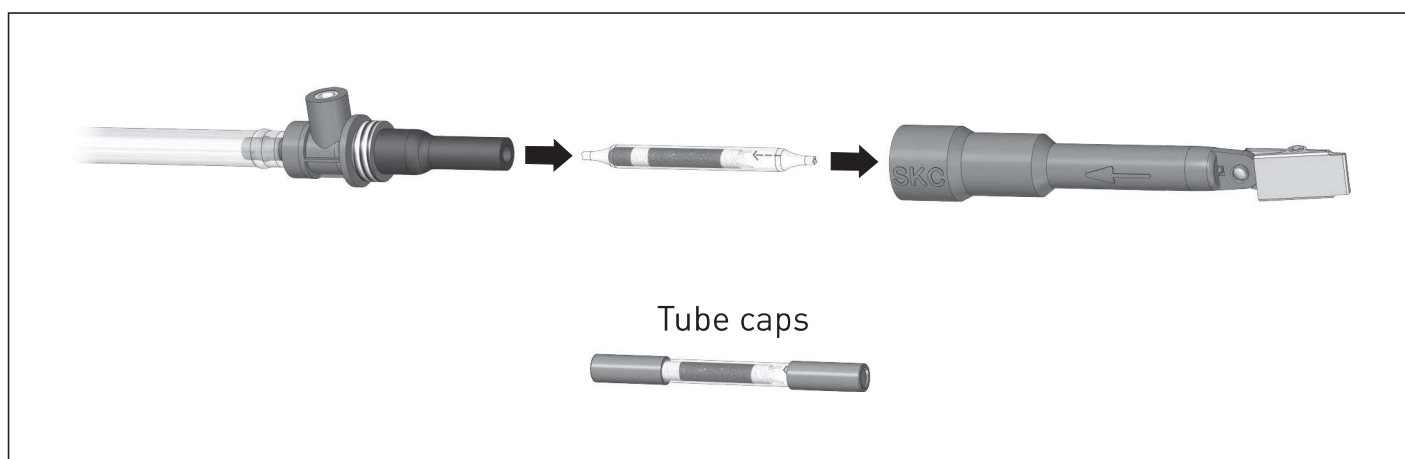

The importance of blanks:

Sample blanks are in general ignored by a lot of people, but do offer an important and required benchmark for accurate samples. Prepare and handle a sorbent tube the same way as the ones being used for the actual sample. DO NOT expose the blank tube to any air and cap it immediately with the red tube covers. When sending the used tubes for analysis include the non-exposed blank as well. This will allow the laboratory to test the blank and take into account any variations which are then applied to the exposed samples.

Impinger sampling can be carried out either as a personal sample with the pump and impinger mounted on a worker, or as a static area sample. For personal sampling the glass impinger is mounted in an impinger pouch with an in-line trap. For static area sampling the glass impinger is mounted in an impinger bracket with a glass trap. Sidekick, Universal and AirChek Touch pumps incorporate mounting points to attach an impinger bracket to the pump.

The trap is very important to ensure that impinger fluid cannot be accidentally drawn into the sample pump mechanism where it can cause significant damage. When the trap is optionally filled with trap sorbent the sorbent will adsorb any evaporated impinger fluid, preventing it from passing through the sample pump.

Note: Although personal sampling is recommended by the HSE and the limits in EH40 are based on personal exposure, consideration must be given to the fact that placing glassware filled with, in some cases, hazardous liquids does present a hazard in itself.

Impingers are typically used at a flow rate of 1.0 litre/min or below. The actual flow rate to be used and quantity and type of impinger fluid will be specified in the particular sampling method. For flow rates of 500 ml/min and below a setup similar to that used when low flow sampling with sorbent tubes is required, with the exception that the impinger and trap assembly is substituted in place of the sorbent tube. Refer to the section on sampling with sorbent tubes for details.

The following instructions describe how to perform a static area sample with an impinger at a flow rate of 1.0 litre/min. Details on the method to be used for personal sampling are also included and are identified in italics and contained in brackets.

You will need :-

- Sample pump (fully charged)
- Glass impinger
- Glass impinger trap and sorbent (*or in-line trap*)
- A length of flexible tubing
- Impinger bracket (*or pouch*)
- Flow calibration device capable of measuring the required flow rate
- Toolkit to adjust the pump flow rate (for pumps with manual flow adjustment)

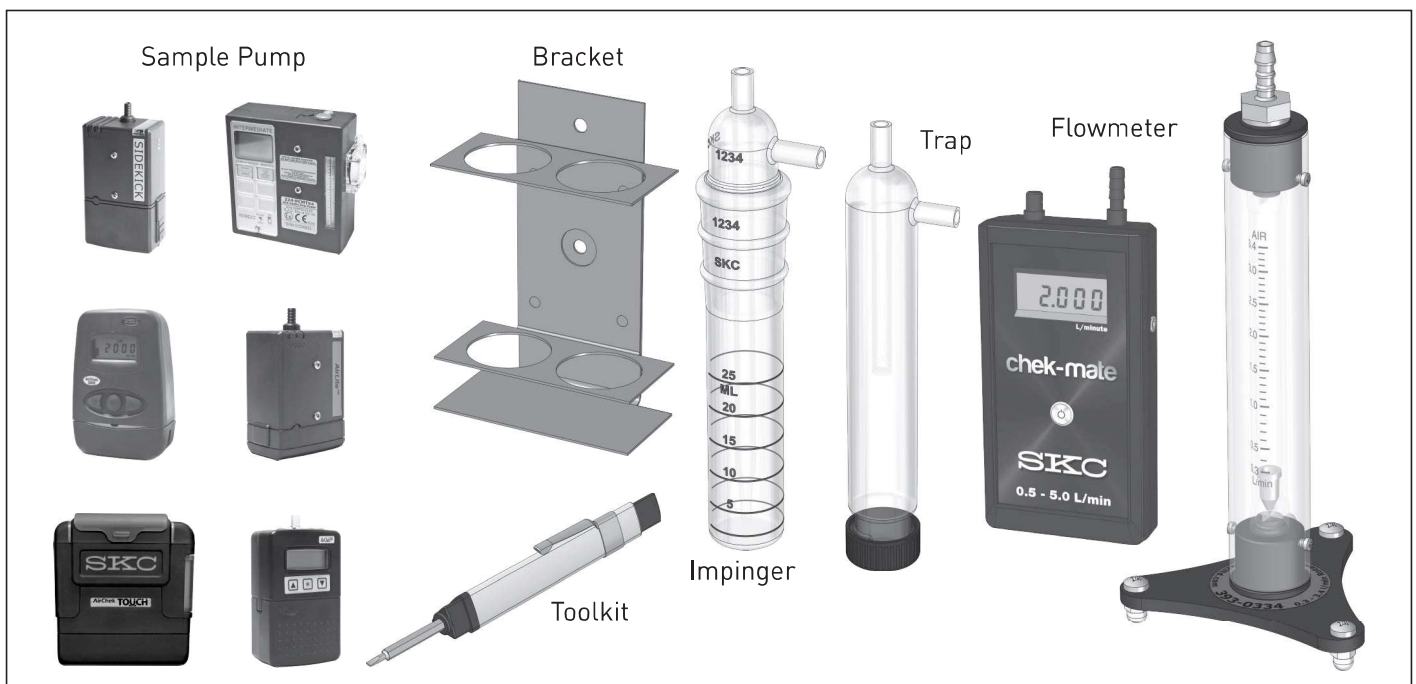

1. Fill the glass trap with trap sorbent until all of the holes in the central tube are covered. Ensure the plastic screw cap is securely fitted

Make sure that the in-line trap is full of sorbent.



2. Remove the top of the impinger and fill it to the desired level with some of the liquid intended to be used for the sample. Refit the impinger top pressing in firmly to ensure a good seal.



3. Fasten the impinger bracket to the pump. The bracket for Sidekick and Universal pumps is attached to the front of the pump using the two screws supplied with the pump. The bracket for the AirChek Touch pump is attached to the belt clip at the rear of the pump. Place the trap and the impinger into the bracket.

(Place the impinger and in-line trap on a suitable surface).



4. Connect the horizontal pipe stub on the impinger to the vertical pipe stub on the trap, and the vertical pipe stub on the trap to the pump inlet hoesetail using two short lengths of flexible tubing, as shown.

(For personal sampling connect from the impinger to the in-line trap with a length of flexible tubing. It does not matter which way around the in-line trap is connected).



5. To calibrate the flow rate connect the vertical pipe stub on the impinger to the outlet hosietail on the flowmeter with a length of flexible tubing. The flow rate is adjusted either manually or electronically, depending on the sample pump being used. Switch the pump on and follow the procedure in the sample pump manual. In the case of the Sidekick, Universal and AirLite pumps use the screwdriver tool to turn the flow adjustment screw. For the AirChek 3000, XR5000 and Touch pumps use the keypad or screen to set the flow rate. As the flow rate is adjusted the flow reading on the flow calibrator should increase or decrease. Check the system for leaks or blockages. Once the flow is set to the required level of 1.0 litre/min, switch the sample pump off.



6. Renew the liquid in the impinger, filling to the correct level as advised in the method you are following. The complete unit can now be placed in the workplace and switched on.

(Mount the sample train [comprising the sample pump, tubing, sorbent trap, impinger and pouch] onto the worker who is to wear it during the sample. A length of tube should be run from the impinger to a position as close to the breathing zone as is practical and comfortable. The pump can be either clipped to a belt or placed into a pouch. Note that the connecting tubing can present a hazard if left to flap around, so measures should be taken to protect the wearer by securing the tubing. Once the pump is mounted to the worker in a satisfactory way it can be switched on).

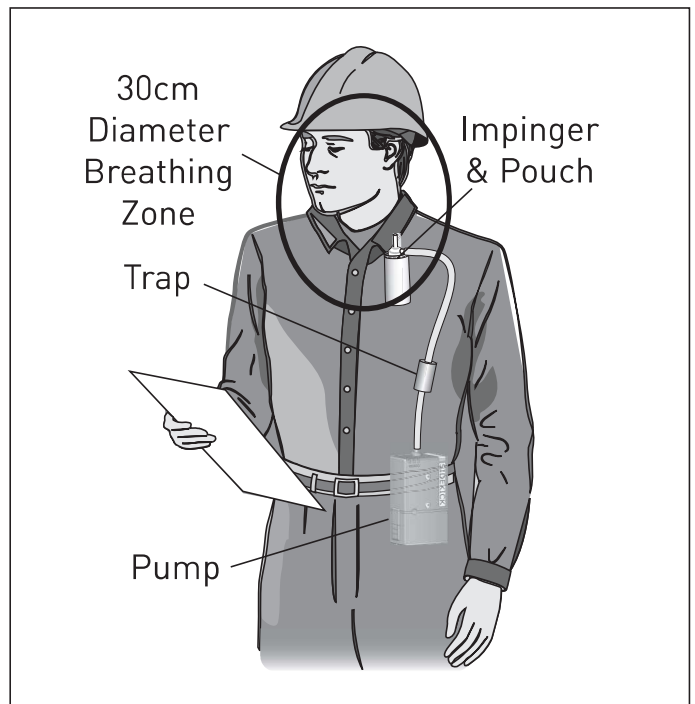

IMPORTANT: The start time of the sample should be noted.

7. As the liquid can evaporate quite quickly the impinger should be checked every 30-45 minutes and topped up with liquid to ensure that the end of the vertical glass tube inside is always covered with liquid.

8. At the end of the sample switch the pump off, and note the finish time. Check the flow rate at the end of the sample. The start and finish times, sample duration, start and finish flow rates and any other relevant details of the sample should be noted down and indexed to the impinger by number or code.

Sample bags are a convenient means of sampling gases and vapours when the concentration is higher than the detection limits of common analytical instruments. Air sampling using bags is usually performed for short periods of time to give an indication of peak airborne concentrations, and is often referred to as a 'grab sample'.

The simplest method of taking a sample into a bag is to use a pump which has both inlet (suction) and outlet (pressure) ports, so that the pump can draw air from the atmosphere and 'push' it into the bag. SKC pumps which can be fitted with an outlet port fitting suitable for filling a bag include the Pocket Pump Touch and the Universal range.

When taking a grab sample the flow rate is not important, however too high a flow rate could lead to over-filling of the sample bag.

When taking a bag sample according to an analytical method that specifies a flow rate, calibrate the pump flow rate before and after sampling as you would with any other sample media, using a flowmeter such as the chek-mate or a rotameter.

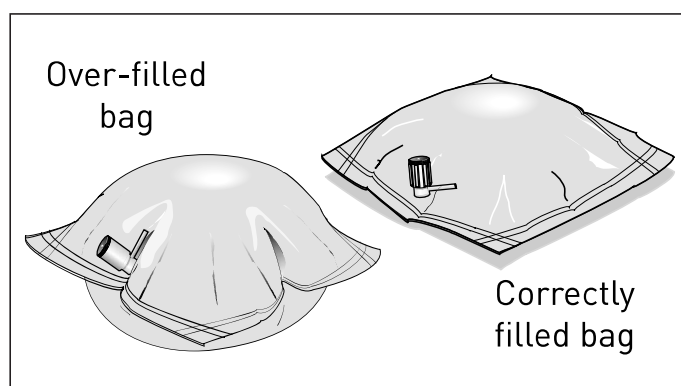

You will need :-

- Sample pump (fully charged)
- Outlet / pressure port fitting for pump
- Sample bag appropriate to the application.
- PTFE tubing

1. Set up the sample pump per the operating instructions, calibrating the pump to the required flow rate if the sample method employed specifies this.
2. Flush the bag before use with purified air or nitrogen.
3. Attach PTFE tubing to the hose/valve fitting of the sample bag, and connect the other end to the outlet port of the pump.
4. To begin sampling, open the valve on the bag fitting (refer to bag operating instructions), then turn on the pump. Avoid filling the bag more than 80% of its maximum volume.
5. After sampling, turn off the pump and close the valve on the bag fitting, ensuring it is sealed securely. Disconnect the bag from the pump and record any pertinent sampling information.
6. Ship the bag to a laboratory for analysis, making sure the bag is packed loosely and padded to minimise the risk of puncture. Bag samples should not be shipped by air unless the cargo cabin is pressurised.

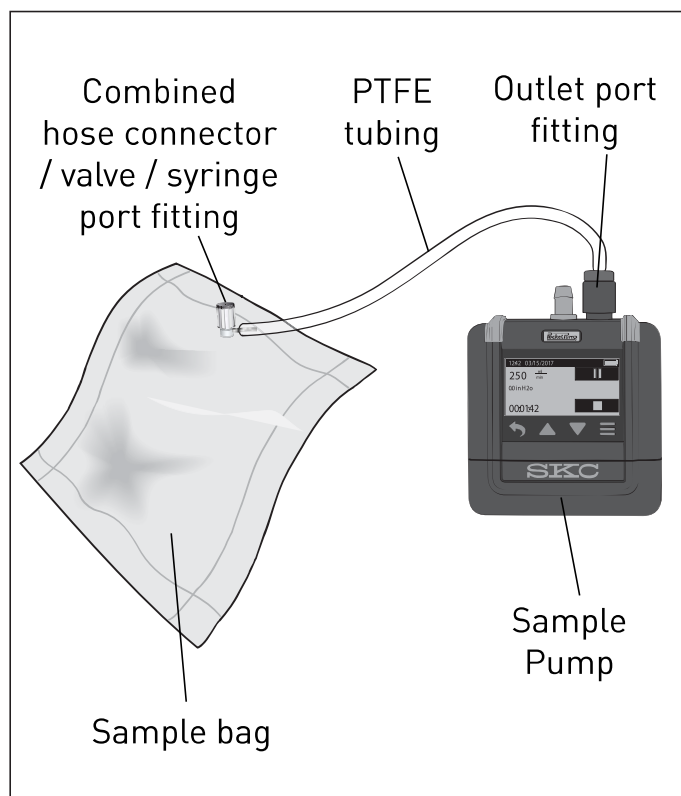

Alternative method of collecting a bag sample

Where there is a need for the air sample not to come into contact with the pump, or where the atmosphere may be aggressive (such as stack sampling), a method of collection using an intermediate container such as the SKC Vac-U-Chamber is recommended. The Vac-U-Chamber is a rigid box that allows sample bags to be filled by using negative pressure provided by a sample pump. The sample does not pass through the pump, therefore ensuring there is no contamination of either sample or pump. For more information please visit our website.

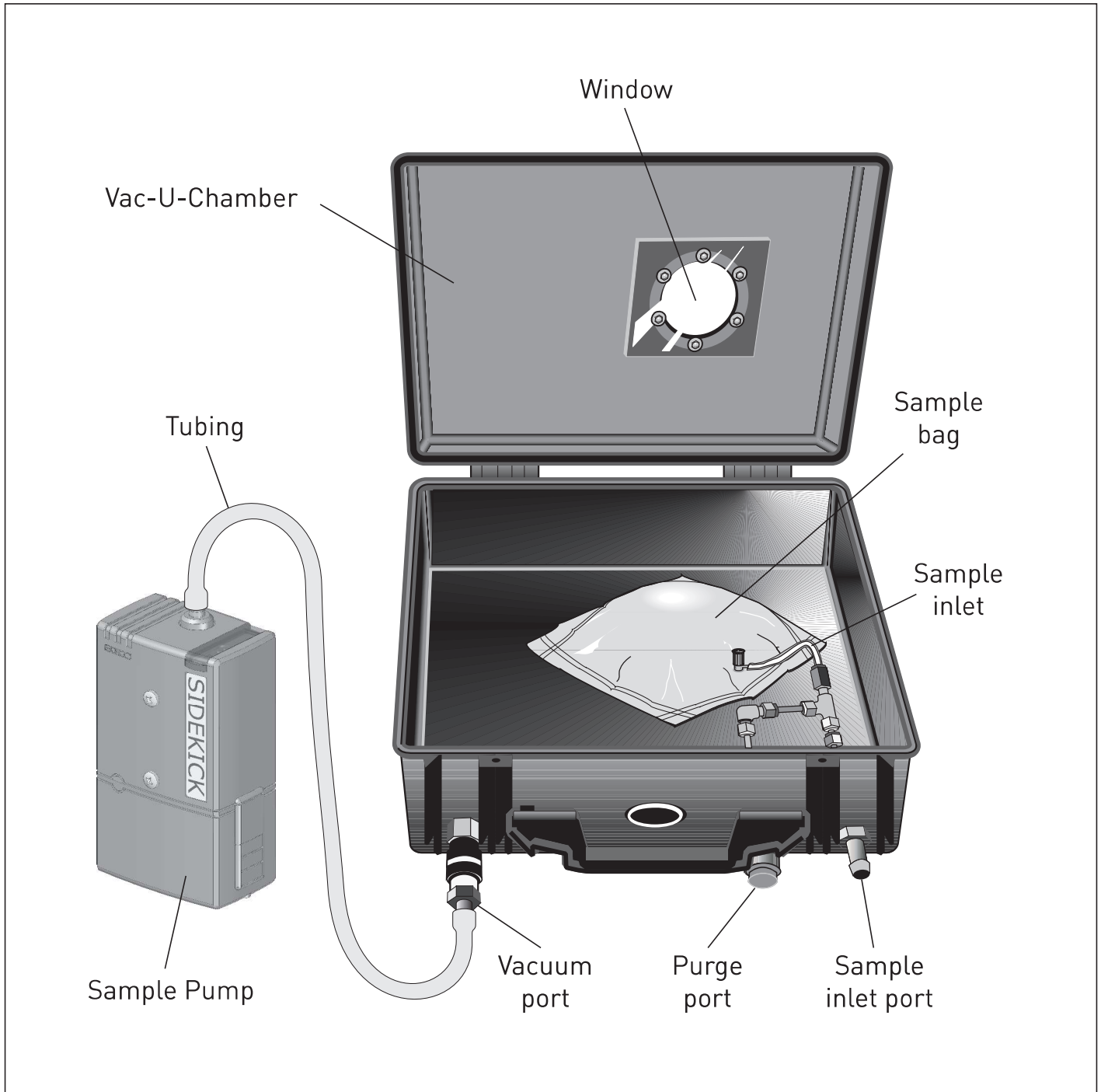

Calculation of the volume of air sampled:

Volume of air sampled = Sample flow rate x sample time

Example: Flow rate = 2 litre/min

Sample time = 8 hours = 8 x 60 = 480 minutes

Volume of air = 2 litre/min x 480 min = 960 litres

Volume of air = 960 / 1000 = 0.96 m³ (cubic metres)

Conversion of ppm (parts per million) to mg/m³ (milligrams per cubic metre):

mg/m³ = ppm x (molecular weight* / 24)

*If the molecular weight of the contaminant is not known it can be determined using a periodic table.

Calculation of time weighted average (TWA):

To determine an 8 hour TWA from more than one sample within any 24 hour period:

$$\text{TWA} = \frac{[C_1 \times T_1] + [C_2 \times T_2] + \dots [C_n \times T_n]}{8}$$

where C is the occupational exposure and T is the time for that exposure.

Example: An operator is exposed to 0.12mg/m³ for 7 hours and 20 minutes.

The 8 hour TWA is therefore 7h20min at 0.12mg/m³ (C1 x T1) plus 40min at 0mg/m³ (C2 x T2).

$$\text{TWA} = \frac{[0.12\text{mg/m}^3 \times 7.33\text{h}] + [0\text{mg/m}^3 \times 0.67\text{h}]}{8} = 0.11\text{mg/m}^3$$

Note: 7h20min = 7.33 hours, 40min = 0.67 hours

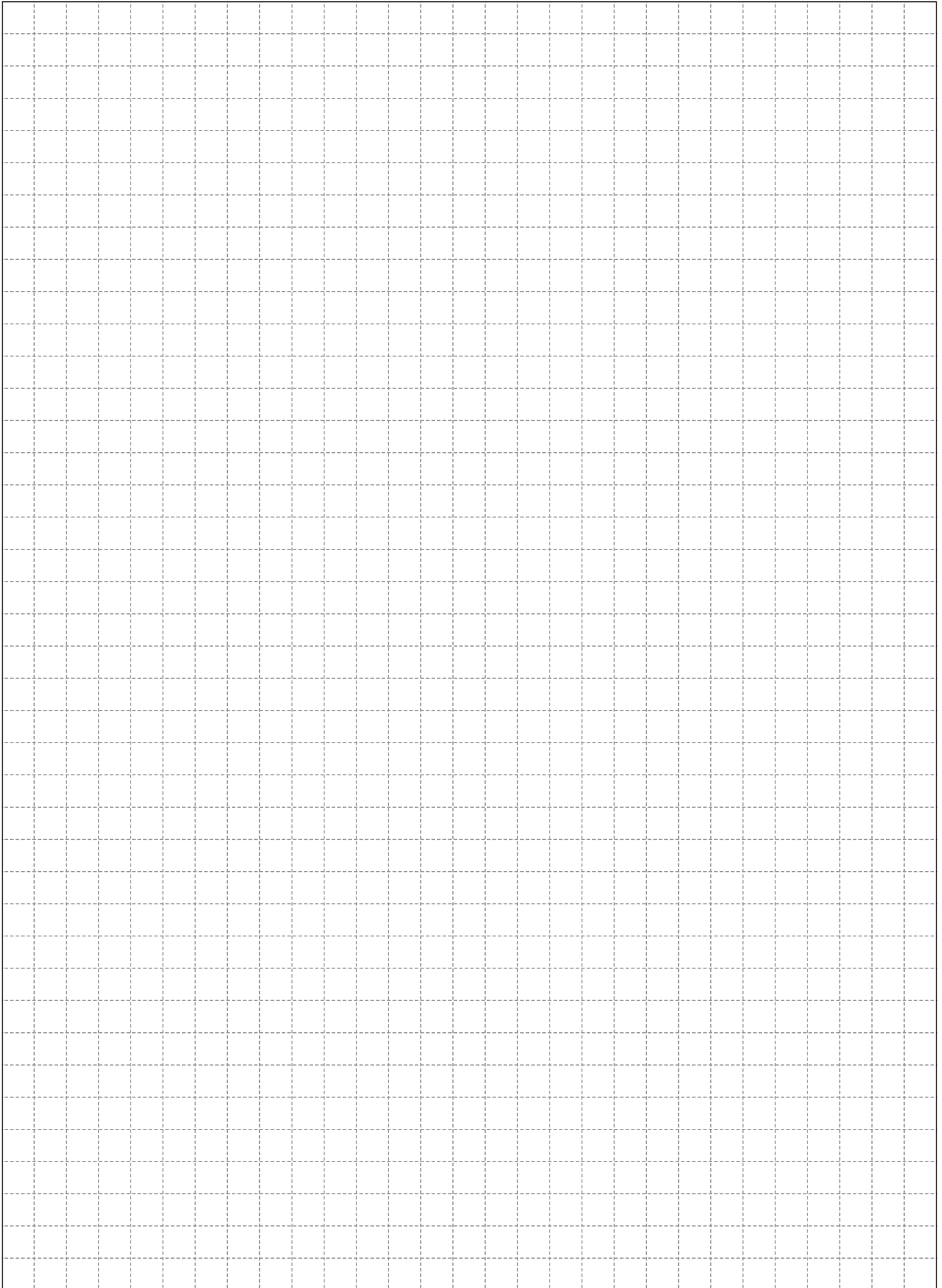

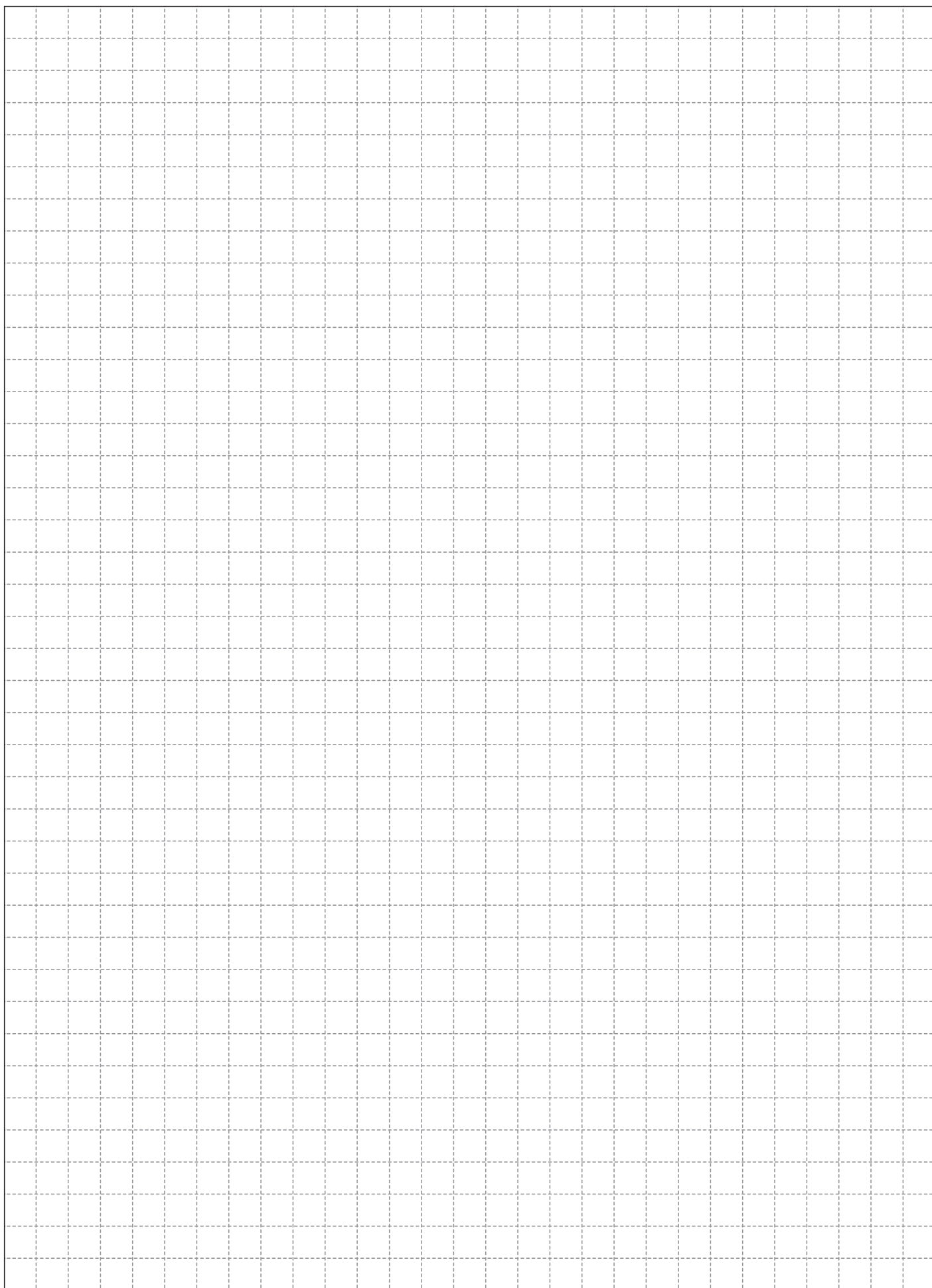



AIR SAMPLING SOLUTIONS & EXPERTISE